

GENUINE RIGGING-PARTS AND ACCESSORIES



Way of Life!

GENUINE RIGGING-PARTS AND ACCESSORIES

Dear Customer,

Quality. Dependability. Innovation. Everything that you expect from your outboard motors is delivered with style by SUZUKI. Demand no less from the products that you choose to enhance your total boating pleasure. Demand GENUINE SUZUKI ACCESSORIES. This catalogue represents our commitment to provide you with the finest products available. From our classic line of matching instruments and gauges to our custom-engineered propellers and rigging items, you can depend on GENUINE SUZUKI ACCESSORIES for optimum performance.

Take a few minutes to browse through this catalogue, and then be sure to visit your AUTHORIZED SUZUKI DEALER for complete ordering information.

Thank you.



TABLE OF CONTENTS

SUZUKI MULTI FUNCTION GAUGE	04
SUZUKI MODULAR INSTRUMENT SYSTEM	12
ANALOG INSTRUMENT	18
SPC ELECTRONIC THROTTLE AND SHIFT SYSTEM	22
CONNECTION BETWEEN ENGINE AND CONTROL SYSTEM	25
MECHANICAL REMOTE CONTROL SYSTEM	26
STEERING	30
ELECTRICAL PARTS	33
ANODE	34
FUEL SYSTEM	35
PROPELLER	38
CARE ITEM	40
MAINTENANCE ITEM	41
BATTERIES	43
ALARM SYSTEMS	43
APPLICATION CHART	44
CLOTHING AND MERCHANDISE	46

REFERENCE

Part Number	15-digit alpha-numerical number shows Part Number to be used for ordering.
Gauge Size	Shows the size (2" or 4") of the gauge.
Background	Shows a main color of display panel on the front of a gauge.
Applicable Model	Shows typical or recommended models of ENGINES that RIGGING-PARTS and ACCESSORIES can be installed to.
Maximum Speed	Shows maximum speed that SPEEDOMETER displays.
kph	Kilometers Per Hour
mph	Miles Per Hour
knots	Knots

MODEL NAME AND ENGINE NUMBER

NOTE

Items and their part numbers showing in this catalogue are basically applicable to models of following engine numbers.

Please consult your local dealers regarding other models and their rigging-parts and accessories.

model	engine number	model	engine number	model	engine number
DF300AP	30002P-410001~	DF140AT	14003F-410001~	DF40A	04003F-410001~
DF250AP	25003P-410001~	DF140AZ	14003Z-410001~	DF25	02503F-410001~
DF250T	25003F-410001~	DF115AT	11503F-410001~	DF20A	02002F-410001~
DF250Z	25003Z-410001~	DF115AZ	11503Z-410001~	DF15A	01504F-410001~
DF225T	22503F-410001~	DF100AT	10003F-410001~	DF9.9B	00995F-410001~
DF225Z	22503Z-410001~	DF90A	09003F-410001~	DF9.9A	00994F-410001~
DF200T	20002F-410001~	DF80A	08002F-410001~	DF8A	00801F-410001~
DF200Z	20002Z-410001~	DF70A	07003F-410001~	DF6	00602F-410001~
DF175T	17502F-410001~	DF60AV	06003F-410001~	DF5	00502F-410001~
DF175Z	17502Z-410001~	DF60A	06002F-410001~	DF4	00402F-410001~
DF150T	15002F-410001~	DF50AV	05004F-410001~	DF2.5	00252F-410001~
DF150Z	15002Z-410001~	DF50A	05003F-410001~		

SUZUKI MULTI FUNCTION GAUGE



34200-87L12-000 **001**

Applicable Model DF9.9B/15A/20A/40A-300AP

THE SUZUKI MULTI FUNCTION GAUGE (SMFG) gives you various information in real time.

Main features include;

- ① displays 22 kinds of valuable information for boat operation and engine condition. could display log speed and real time fuel consumption by plug-in connecting with Suzuki Modular Instrument System (SMIS), which is available as option. (The optional sender is also required to display log speed.)
- ② 5 types of display mode are available for you to select your favorite display mode.
- ③ has alert function for your engine malfunctions and indicates the interval of the engine oil change.
 - a) automatically displays 6 kinds of your engine malfunctions.
 - b) indicates appropriate timing of engine oil change.
- ④ 4.3 inch full-color liquid crystal screen with back light and can be switched to daytime or nighttime display mode for better visibility.
- ⑤ optional analog image display or digital image display can be selected.
- ⑥ can display maximum 2 engines at same time.
- ⑦ applicable to maximum 2 stations and 4 engines using multiple SMFGs.
- ⑧ newly set up 6 kinds of rigging parts kits for your convenience to have all necessary parts to fit the SMFG to your boat.
- ⑨ also includes navigation function to easily find the distance and direction to your destination or home port.

Display Information

		Displayed Items in Multi-Function Gauge	
Boat Operation Information	Boat Operation Information	<input type="checkbox"/>	
	Ground Speed	<input type="checkbox"/>	
	Shift Position	<input type="checkbox"/>	
	Trim Position	<input type="checkbox"/>	
Navigation Information	Fuel Level	<input type="checkbox"/>	
	Fuel Information	Consumption/H (Average)	<input type="checkbox"/>
		Distance/L (Average)	<input type="checkbox"/>
	Compass Direction	<input type="checkbox"/>	
	Current Position	<input type="checkbox"/>	
	Course	<input type="checkbox"/>	
	Direction of the Home Port	<input type="checkbox"/>	
	Distance to the Home Port	<input type="checkbox"/>	
	Direction of the Destination	<input type="checkbox"/>	
	Distance to the Destination	<input type="checkbox"/>	
	Nautical Time	<input type="checkbox"/>	
Clock	<input type="checkbox"/>		
Engine Data	Battery Voltage	<input type="checkbox"/>	
	Engine Temperature	<input type="checkbox"/>	
	Engine Operation Hours	<input type="checkbox"/>	
	Operation Hours after Oil Change	<input type="checkbox"/>	
	Various Warnings	<input type="checkbox"/>	
	Error Information	<input type="checkbox"/>	

Screen Selection

5 types of screen display are available.

(1) Full Display (either digital image of display or analog image of display can be selected)

Features:

- Tachometer
- Shift position
- Speedometer
- Trim gauge
- GPS time
- Trip hour
- Distance to homeport and destination
- Navigation compass
- Fuel manager
- Fuel gauge

Digital Display



Daytime



Analog Display



Screen for Night time



Nighttime

(2) Simple Display (Alerts engine malfunction and indicates timing of oil change)

Features:

- Tachometer
- Shift position
- Speedometer
- Fuel gauge
- GPS time
- Navigation compass
- Trim gauge

For Single Engine System(Digital)



For Single Engine System(Analog)



Screen for Night time



For Dual Engine System(Digital)



For Dual Engine System(Analog)



Screen for Night time



(3) Navigation Display



Features:

- Compass
- GPS time
- Trip hour
- Distance to homeport and destination
- Latitude and longitude

(4) Fuel Information Display



Features:

- Fuel level of each tank
- Fuel flow
- Fuel consumption per hour
- Sailing distance per liter or gallon
- Distance to homeport and destination

(5) Engine Information Display

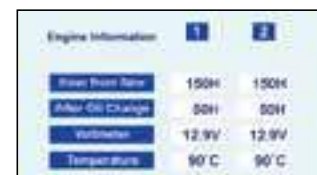

Features:

- Total hour
- Hour after oil change
- Voltmeter
- Coolant water temperature

Engine Warning Displays

The Multi Function Gauge has 6 alert functions for engine malfunctions and indicates timing of engine oil changes. Makes it sound like everyone should anticipate a malfunction.

(1) Low Battery Voltage

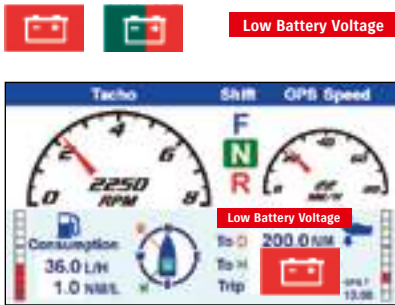

(3) Low Oil Pressure

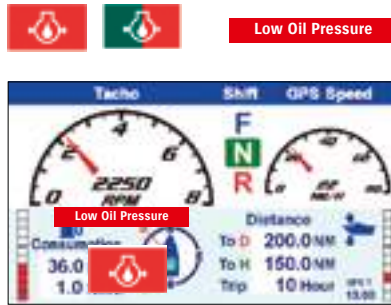

(5) Water in Fuel

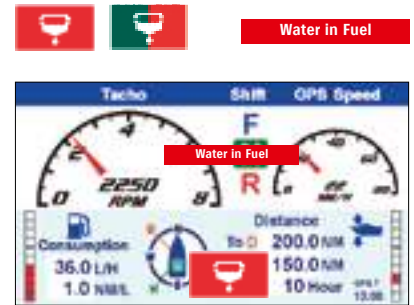

(2) Engine Error

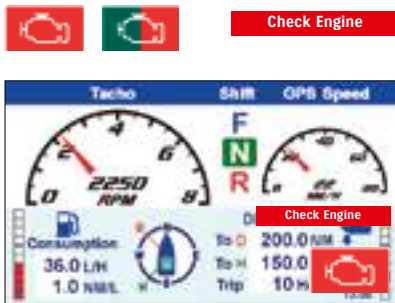

(4) Overheating

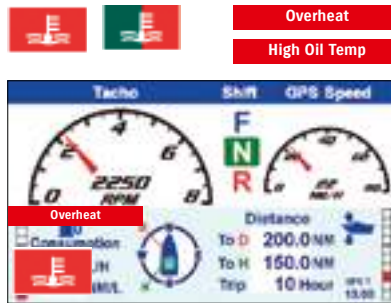

(6) Over Revolution

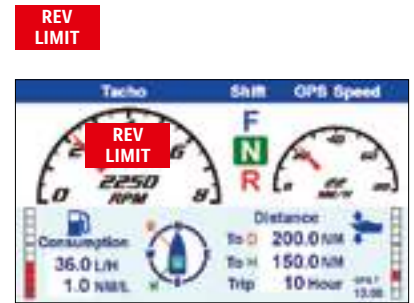

(7) Oil Change Timing

Indicate appropriate timing of engine oil change.

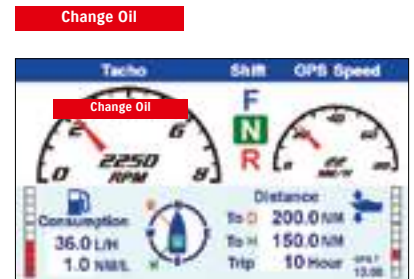

Multi Function Gauge Kit

Newly set up 6 kinds of rigging parts kits for your convenience to have all necessary parts to fit the SMFG to your boat.

- ① For 1st station, up to 2 engines with mechanical remote control ② For 1st station, 3 or 4 engines with mechanical remote control ③ For 1st station, up to 2 engines with electronic throttle and shift

KIT Part Number	Component Part No.	Component Part Name	QTY
34011-87L00-000	34200-87L12-000	GAUGE ASSY, MULTI	1
	36661-87L00-000	ADAPTER COMP, GAUGE	1
	36663-98J10-000	HARNES ASSY, ACTIVE HUB PWR L	1
	36990-87D00-000	TERMINAL & SLEEVE SET	1
	39950-87L00-000	MODULE ASSY, GPS RECEIVER	1

KIT Part Number	Component Part No.	Component Part Name	QTY
34011-87L10-000	34200-87L12-000	GAUGE ASSY, MULTI	2
	36661-87L00-000	ADAPTER COMP, GAUGE	2
	36663-88L00-000	HARNES ASSY, NETWORK POWER	1
	36663-98J10-000	HARNES ASSY, ACTIVE HUB PWR L	1
	990C0-88110-000	CONNECTOR COMP, BRANCH	3
	36665-87L00-000	ADAPTER, GAUGE FOR MULT	1
	36665-88L00-000	UNIT COMP, RESISTOR FEMALE	1
	36665-88L10-000	UNIT COMP, RESISTOR MALE	1
	36666-87L00-000	WIRE COMP, NETWORK	2
	36990-87D00-000	TERMINAL & SLEEVE SET	1
	39950-87L00-000	MODULE ASSY, GPS RECEIVER	1

KIT Part Number	Component Part No.	Component Part Name	QTY
34011-87L20-000	34200-87L12-000	GAUGE ASSY, MULTI	1
	36661-87L11-000	ADAPTER COMP, GAUGE	1
	36663-98J10-000	HARNES ASSY, ACTIVE HUB PWR L	1
	36990-87D00-000	TERMINAL & SLEEVE SET	1
	39950-87L00-000	MODULE ASSY, GPS RECEIVER	1

GAUGE ADAPTER



36661-87L00-000 002
 Applicable Model DF9.9B/15A/20A/
 40A-140AT/Z/150T/Z/175T/
 Z/200T/Z-250T/Z/



36661-87L11-000 003
 For drive-by-wire models
 Applicable Model DF150TG/ZG/175TG/ZG/
 250AP/300AP



NEW
36664-87L00-000 004
 For 2nd station, up to 2 engines
 Applicable Model DF40A-300AP



NEW
36665-87L00-000 005
 For using multiple SMFGs
 Applicable Model DF40A-300AP



NEW
36667-87L00-000 006
 For 3 or 4 engines with electric throttle
 and shift
 Applicable Model DF150TG-300AP

GPS RECEIVER MODULE



39950-87L00-000 007
 Applicable Model DF9.9B/15A/20A/40A-300AP

SMIS NETWORK WIRE



36666-87L00-000 008
 Applicable Model DF9.9B/15A/20A/40A-300AP

POWER CABLE



36663-98J00-000 009
 2.5 meters
 Applicable Model DF9.9B/15A/20A/40A-300AP

36663-98J10-000 010
 6.0 meters
 Applicable Model DF9.9B/15A/20A/40A-300AP

④ For 1st station, 3 or 4 engines with electronic throttle and shift

KIT Part Number	Component Part No.	Component Part Name	QTY
34011-87L30-000	34200-87L12-000	GAUGE ASSY, MULTI	2
	36661-87L11-000	ADAPTER COMP, GAUGE	2
	36663-88L00-000	HARNESS ASSY, NETWORK POWER	1
	36663-98J10-000	HARNESS ASSY, ACTIVE HUB PWR L	1
	990C0-88110-000	CONNECTOR COMP, BRANCH	3
	36665-87L00-000	ADAPTER, GAUGE FOR MULT	1
	36665-88L00-000	UNIT COMP, RESISTOR FEMALE	1
	36665-88L10-000	UNIT COMP, RESISTOR MALE	1
	36666-87L00-000	WIRE COMP, NETWORK	2
	36990-87D00-000	TERMINAL & SLEEVE SET	1
	39950-87L00-000	MODULE ASSY, GPS RECEIVER	1

⑤ For 2nd station, up to 2 engines*

KIT Part Number	Component Part No.	Component Part Name	QTY
34011-87L40-000	34200-87L12-000	GAUGE ASSY, MULTI	1
	36662-88L00-000	WIRE COMP, 25 EXTENSION	1
	36663-88L00-000	HARNESS ASSY, NETWORK POWER	1
	36664-87L00-000	ADAPTER, GAUGE FOR DUAL STATION	1
	990C0-88110-000	CONNECTOR COMP, BRANCH	3
	36665-87L00-000	ADAPTER, GAUGE FOR MULT	1
	36665-88L00-000	UNIT COMP, RESISTOR FEMALE	1
	36665-88L10-000	UNIT COMP, RESISTOR MALE	1
	36666-87L00-000	WIRE COMP, NETWORK	2
	36682-92E00-000	WIRE COMP, TRIM METER	1

⑥ For 2nd station, 3 or 4 engines*

KIT Part Number	Component Part No.	Component Part Name	QTY
34011-87L50-000	34200-87L12-000	GAUGE ASSY, MULTI	2
	36662-88L00-000	WIRE COMP, 25 EXTENSION	1
	36664-87L00-000	ADAPTER, GAUGE FOR DUAL STATION	2
	990C0-88110-000	CONNECTOR COMP, BRANCH	2
	36666-87L00-000	WIRE COMP, NETWORK	2
	36682-92E00-000	WIRE COMP, TRIM METER	2

* Kit No. ⑤ & ⑥ can be used for mechanical remote control system and electric throttle and shift system.

Example of connection for DF9.9BR/15AR/20AR/40A-250 with

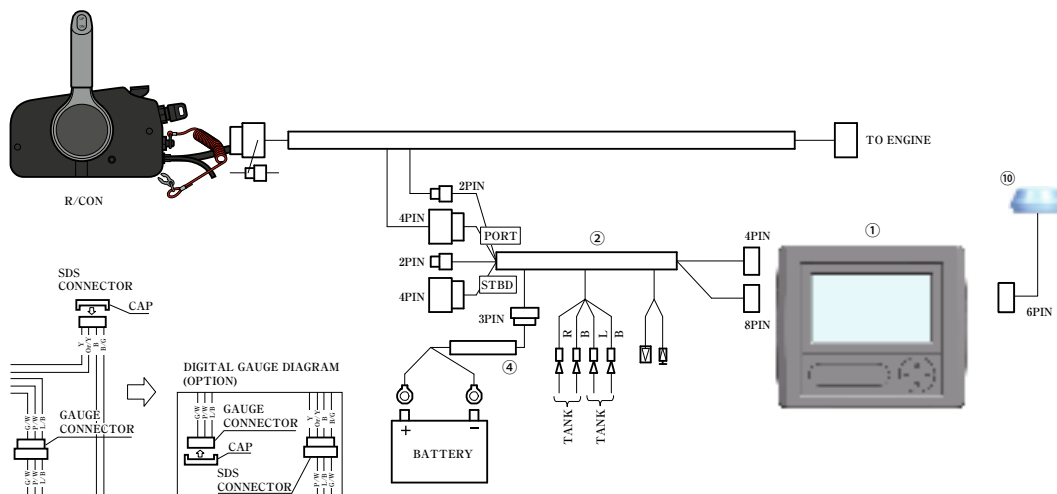

For 1 station, up to dual engines

No.	Component Part Name	Component Part No.	Needed Q'ty	1st station kit 34011-87L00-000	Q'ty
①	GAUGE ASSY, MULTI	34200-87L12-000	1	1	1
②	ADAPTER COMP, GAUGE	36661-87L00-000	1	1	1
④	HARNESS ASSY, ACTIVE HUB PWR L	36663-98J10-000	1	1	1
⑩	MODULE ASSY, GPS RECEIVER	39950-87L00-000	1	1	1
⑫	ENGINE TO INTERFACE WIRE SET	36660-89L00-000	1*	1**	1**
	TERMINAL & SLEEVE SET	36990-87D00-000	1	1	1

* 36660-89L00 is sold separately.

** There are several models which should be installed in different ways. For more details, please ask Suzuki dealers.

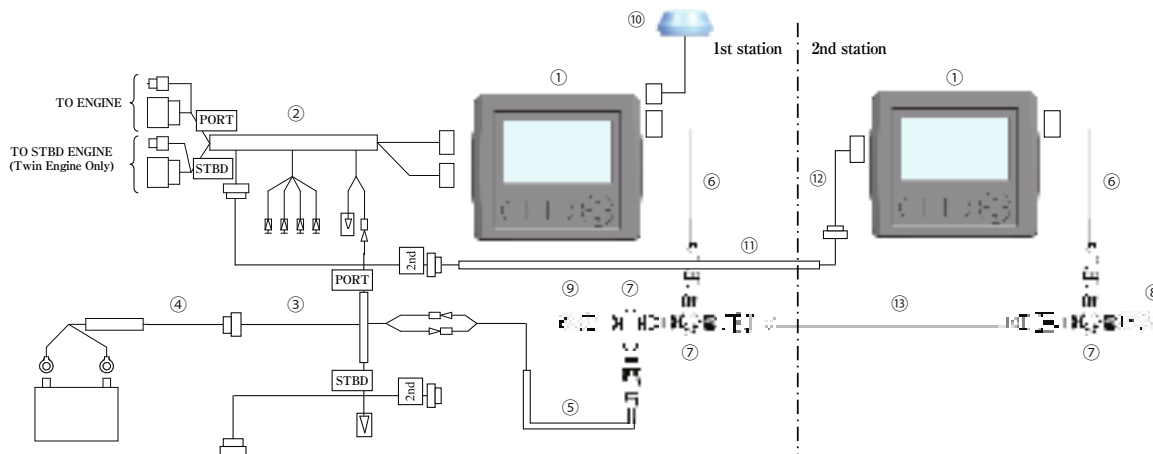

For 2 stations, up to dual engines

No.	Component Part Name	Component Part No.	Needed Q'ty	1st station kit 34011-87L00-000	2nd station kit 34011-87L40-000
①	GAUGE ASSY, MULTI	34200-87L12-000	2	1	1
②	ADAPTER COMP, GAUGE	36661-87L00-000	1	1	1
③	ADAPTER, GAUGE FOR MULTI	36665-87L00-000	1		1
④	HARNESS ASSY, ACTIVE HUB PWR L	36663-98J10-000	1	1	
⑤	HARNESS ASSY NETWORK POWER	36663-88L00-000	1		1
⑥	WIRE COMP, NETWORK	36666-87L00-000	2		2
⑦	CONNECTOR COMP, BRANCH	990C0-88110-000	3		3
⑧	UNIT COMP, RESISTOR MALE	36665-88L10-000	1		1
⑨	UNIT COMP, RESISTOR FEMALE	36665-88L00-000	1		1
⑩	MODULE ASSY, GPS RECEIVER	39950-87L00-000	1	1	
⑪	WIRE COMP EXTENSION	36682-92E00-000	1		1
⑫	ADAPTER, GAUGE FOR DUAL STATION	36664-87L00-000	1		1
⑬	WIRE COMP, EXTENSION	36662-88L00-000	1		1
	TERMINAL & SLEEVE SET	36990-87D00-000	1	1	

mechanical remote control system

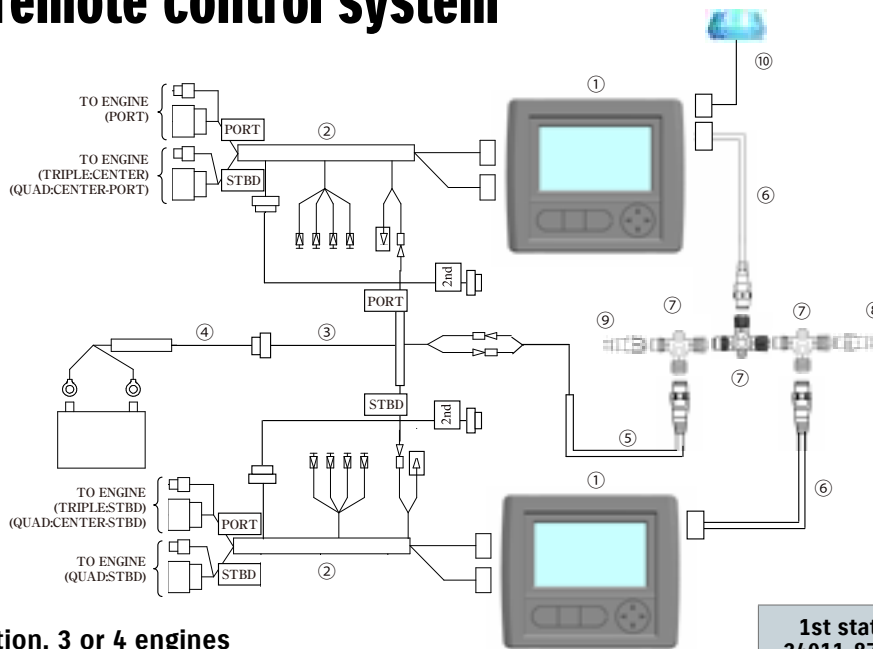

For 1 station, 3 or 4 engines

1st station kit
34011-87L10-000

No.	Component Part Name	Component Part No.	Needed Q'ty	Q'ty
①	GAUGE ASSY, MULTI	34200-87L12-000	2	2
②	ADAPTER COMP, GAUGE	36661-87L00-000	2	2
③	ADAPTER , GAUGE FOR MULTI	36665-87L00-000	1	1
④	HARNESS ASSY , ACTIVE HUB PWR L	36663-98J10-000	1	1
⑤	HARNESS ASSY NETWORK POWER	36663-88L00-000	1	1
⑥	WIRE COMP, NETWORK	36666-87L00-000	2	2
⑦	CONNECTOR COMP, BRANCH	990C0-88110-000	3	3
⑧	UNIT COMP, RESISTOR MALE	36665-88L10-000	1	1
⑨	UNIT COMP, RESISTOR FEMALE	36665-88L00-000	1	1
⑩	MODULE ASSY,GPS RECEIVER	39950-87L00-000	1	1
	TERMINAL & SLEEVE SET	36990-87D00-000	1	1

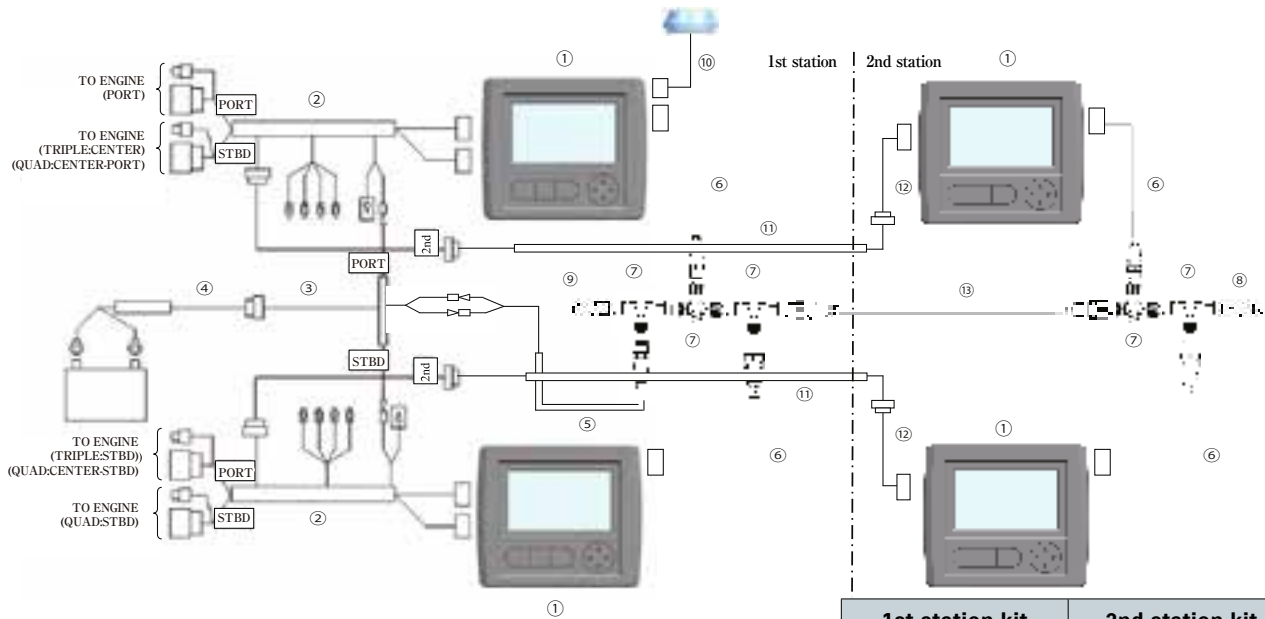

For 2 stations, 3 or 4 engines

1st station kit
34011-87L10-000

2nd station kit
34011-87L50-000

No.	Component Part Name	Component Part No.	Needed Q'ty	Q'ty	Q'ty
①	GAUGE ASSY, MULTI	34200-87L12-000	4	2	2
②	ADAPTER COMP, GAUGE	36661-87L00-000	2	2	
③	ADAPTER , GAUGE FOR MULTI	36665-87L00-000	1	1	
④	HARNESS ASSY , ACTIVE HUB PWR L	36663-98J10-000	1	1	
⑤	HARNESS ASSY NETWORK POWER	36663-88L00-000	1	1	
⑥	WIRE COMP, NETWORK	36666-87L00-000	4	2	2
⑦	CONNECTOR COMP, BRANCH	990C0-88110-000	5	3	2
⑧	UNIT COMP, RESISTOR MALE	36665-88L10-000	1	1	
⑨	UNIT COMP, RESISTOR FEMALE	36665-88L00-000	1	1	
⑩	MODULE ASSY,GPS RECEIVER	39950-87L00-000	1	1	
⑪	WIRE COMP, EXTENSION	36682-92E00-000	2		2
⑫	ADAPTER, GAUGE FOR DUAL STATION	36664-87L00-000	2		2
⑬	WIRE COMP, EXTENSION	36662-88L00-000	1		1
	TERMINAL & SLEEVE SET	36990-87D00-000	1	1	

Example of connection for DF150TG/ZG/175TG/ZG,DF250AP/300AP

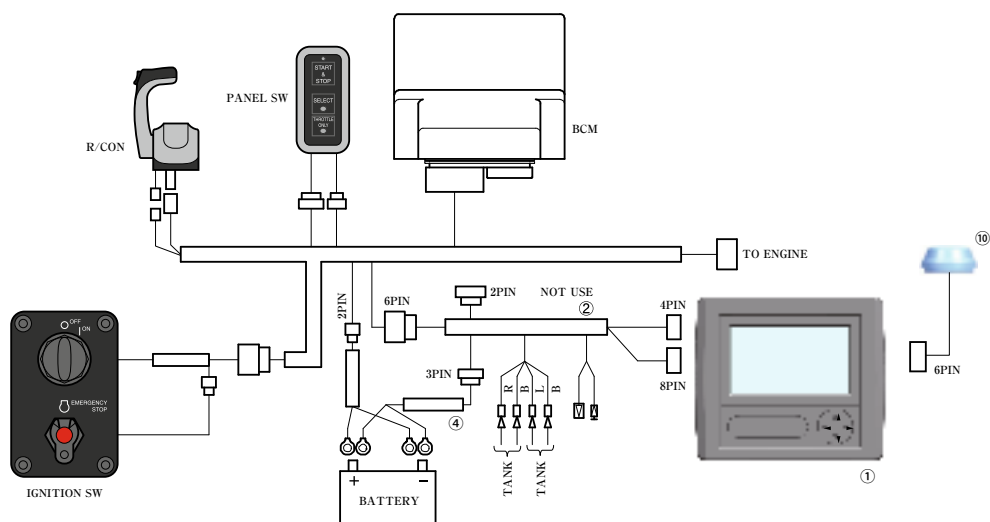

For 1 station, up to dual engines

No.	Component Part Name	Component Part No.	Needed Q'ty	1st station kit 34011-87L20
①	GAUGE ASSY, MULTI	34200-87L12-000	1	1
②	ADAPTER COMP, GAUGE	36661-87L11-000	1	1
④	HARNESS ASSY, ACTIVE HUB PWR L	36663-98J10-000	1	1
⑩	MODULE ASSY,GPS RECEIVER	39950-87L00-000	1	1
	TERMINAL & SLEEVE SET	36990-87D00-000	1	1

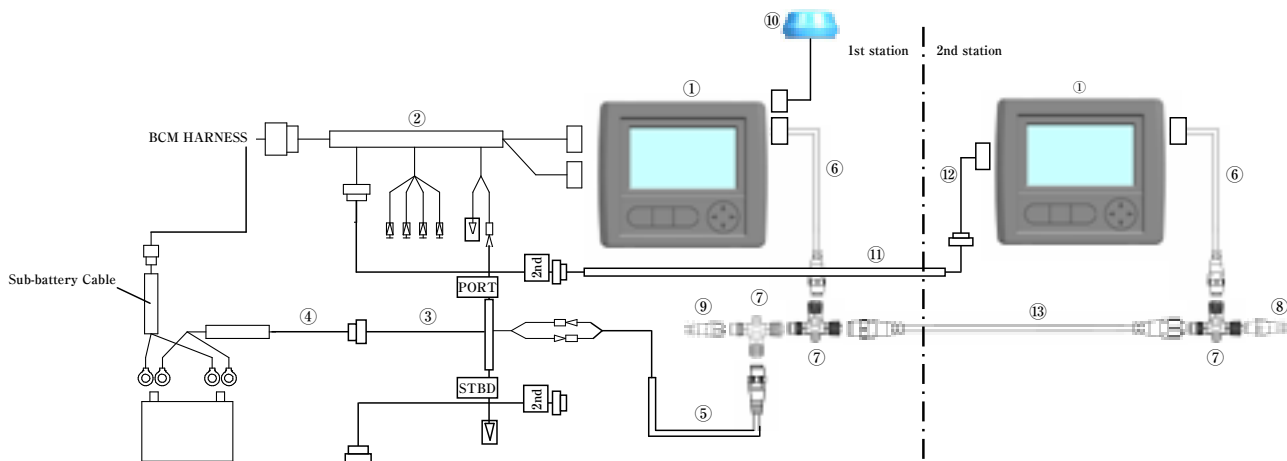

For 2 stations, up to dual engines

No.	Component Part Name	Component Part No.	Needed Q'ty	1st station kit 34011-87L20-000	2nd station kit 34011-87L40-000
①	GAUGE ASSY, MULTI	34200-87L12-000	2	1	1
②	ADAPTER COMP, GAUGE	36661-87L11-000	1	1	
③	ADAPTER, GAUGE FOR MULTI	36665-87L00-000	1		1
④	HARNESS ASSY, ACTIVE HUB PWR L	36663-98J10-000	1	1	
⑤	HARNESS ASSY NETWORK POWER	36663-88L00-000	1		1
⑥	WIRE COMP, NETWORK	36666-87L00-000	2		2
⑦	CONNECTOR COMP, BRANCH	990C0-88110-000	3		3
⑧	UNIT COMP, RESISTOR MALE	36665-88L10-000	1		1
⑨	UNIT COMP, RESISTOR FEMALE	36665-88L00-000	1		1
⑩	MODULE ASSY,GPS RECEIVER	39950-87L00-000	1	1	
⑪	WIRE COMP, TRIM METER	36682-92E00-000	1		1
⑫	ADAPTER, GAUGE FOR DUAL STATION	36664-87L00-000	1		1
⑬	WIRE COMP, EXTENSION	36662-88L00-000	1		1
	TERMINAL & SLEEVE SET	36990-87D00-000	1	1	

with electronic throttle and shift system

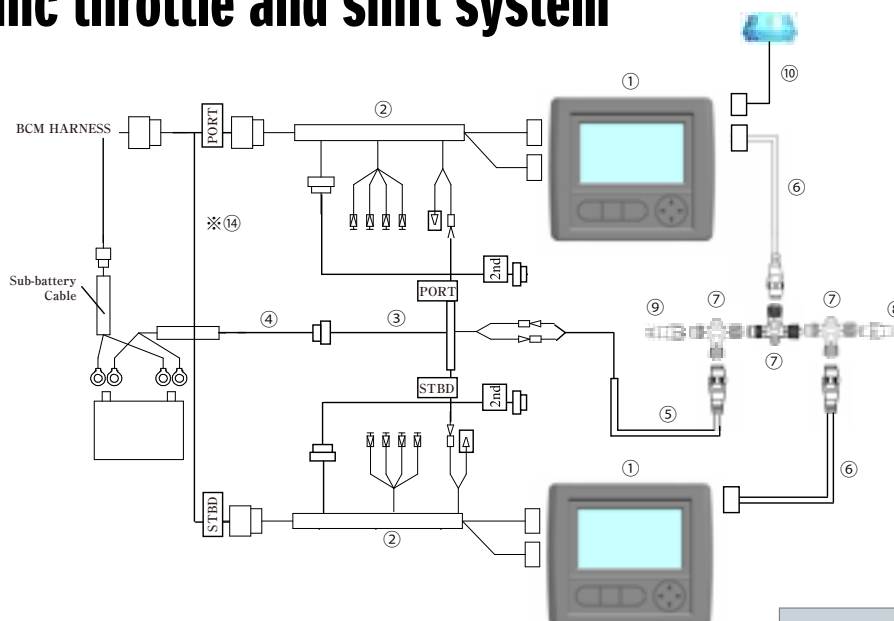

For 1 station, 3 or 4 engines

1st station kit
34011-87L30-000

No.	Component Part Name	Component Part No.	Needed Q'ty	Q'ty
①	GAUGE ASSY, MULTI	34200-87L12-000	2	2
②	ADAPTER COMP, GAUGE	36661-87L11-000	2	2
③	ADAPTER, GAUGE FOR MULTI	36665-87L00-000	1	1
④	HARNESS ASSY, ACTIVE HUB PWR L	36663-98J10-000	1	1
⑤	HARNESS ASSY NETWORK POWER	36663-88L00-000	1	1
⑥	WIRE COMP, NETWORK	36666-87L00-000	2	2
⑦	CONNECTOR COMP, BRANCH	990C0-88110-000	3	3
⑧	UNIT COMP, RESISTOR MALE	36665-88L10-000	1	1
⑨	UNIT COMP, RESISTOR FEMALE	36665-88L00-000	1	1
⑩	MODULE ASSY,GPS RECEIVER	39950-87L00-000	1	1
⑭	ADAPTER, GAUGE FOR MULTI	36667-87L00-000	1*	1*
	TERMINAL & SLEEVE SET	36990-87D00-000	1	1

* 36667-87L00 is sold separately. Required for 3 or 4 engines.

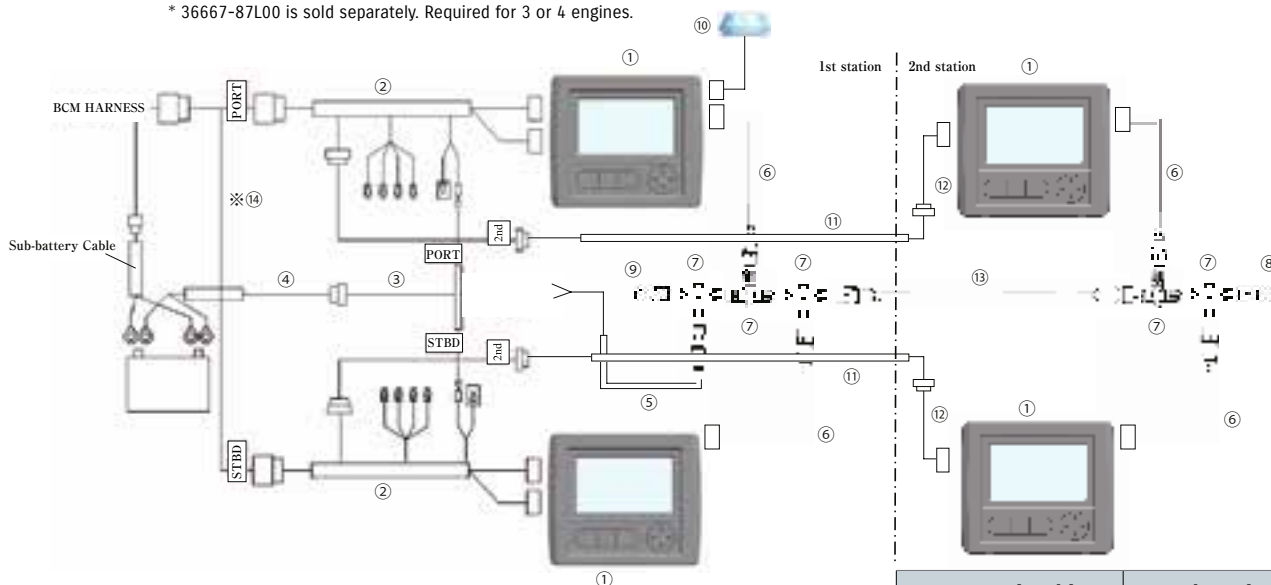

For 2 stations, 3 or 4 engines

1st station kit
34011-87L30-000

2nd station kit
34011-87L50-000

No.	Component Part Name	Component Part No.	Needed Q'ty	Q'ty	Q'ty
①	GAUGE ASSY, MULTI	34200-87L12-000	4	2	2
②	ADAPTER COMP, GAUGE	36661-87L11-000	2	2	
③	ADAPTER, GAUGE FOR MULTI	36665-87L00-000	1	1	
④	HARNESS ASSY, ACTIVE HUB PWR L	36663-98J10-000	1	1	
⑤	HARNESS ASSY NETWORK POWER	36663-88L00-000	1	1	
⑥	WIRE COMP, NETWORK	36666-87L00-000	4	2	2
⑦	CONNECTOR COMP, BRANCH	990C0-88110-000	5	3	2
⑧	UNIT COMP, RESISTOR MALE	36665-88L10-000	1	1	
⑨	UNIT COMP, RESISTOR FEMALE	36665-88L00-000	1	1	
⑩	MODULE ASSY,GPS RECEIVER	39950-87L00-000	1	1	
⑪	WIRE COMP, EXTENSION	36682-92E00-000	2		2
⑫	ADAPTER, GAUGE FOR DUAL STATION	36664-87L00-000	2		2
⑬	WIRE COMP, EXTENSION	36662-88L00-000	1		1
⑭	ADAPTER, GAUGE FOR MULTI	36667-87L00-000	1*	1*	
	TERMINAL & SLEEVE SET	36990-87D00-000	1	1	

* 36667-87L00 is sold separately. Required for 3 or 4 engines.

SUZUKI MODULAR INSTRUMENT SYSTEM

SUZUKI MODULAR INSTRUMENT SYSTEM (SMIS) uses an easy to connect and expandable cable system to transmit graphic and numerical data to Multi-Function gauges. Easy to set up and install system can be used with nearly any boat and DF300 SUZUKI Outboard. Connected to the NMEA2000® compatible system, the gauges can display real-time readings from compatible electronic probes and the exclusive SMIS engine interface to monitor all engine functions. (Engine Monitor with 4" gauge only)

APPLICABLE MODELS : DF9.9BR/15AR/20AR/40AT/50AT/50AV/60AT/60AV/70AT/80AT/90AT/100A-300A

SMIS MULTI-FUNCTION GAUGE

The 4" multi-function gauge uses a state-of-the-art high-contrast, dot matrix display to monitor real-time graphic and numerical digital data. When connected into the SMIS system, it can monitor all engine functions, act as a speedometer, tachometer, GPS*, and many others. (*GPS requires additional hardware.)

The 2" multi-function gauge is capable of all functions of the 4" gauge except diagnostic informations. When connected to the SMIS system, it can be programmed to monitor all other functions.

4" SMIS MULTI-FUNCTION GAUGE



Quad analog page as a tachometer, a volt meter, a water-pressure gauge and a speedometer for single engine

990C0-88161-000 011

with a gray bezel + a T-connector (990C0-88110-000) + Operation & Installation Manual

2" SMIS MULTI-FUNCTION GAUGE



Fuel manager page

990C0-88150-000 012

with a gray bezel + a T-connector (990C0-88110-000) + Operation & Installation Manual

Examples of display*



Engine trim page as a trim gauge for single engine



Fuel manager page as a fuel gauge



Single analog page as a tachometer for single engine



Dual digital page as a hour meter and a speedometer for single engine



Single analog page as a speedometer



Diagnostics page

Examples of display*



as a volt meter for single engine



Fuel manager page



Engine trim page as a trim gauge for single engine

* The detail instructions of display-operation are explained in the Operation & Installation Manual.

GAUGE KIT

4" GAUGE KIT

990C0-88162-KIT **013**

This kit contains basic components to install digital gauge.



2" GAUGE KIT

990C0-88150-KIT **014**

34011-89L01-000

This kit supplements analog gauges to display additional information, and it can display information which analog gauge system cannot indicate such as fuel consumption.

34011-89L01-000 is for DF9.9B/15A/20A, and includes 36660-89L00-000 instead of 990C0-88136-000.

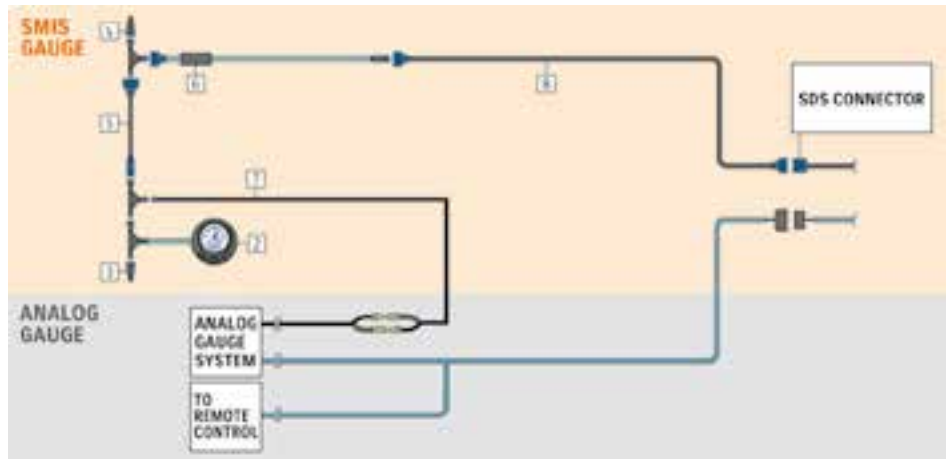

Available for your convenience. Refer to the following chart for the contents.

Contents						
part name	part number	quantity	quantity			
			4" Gauge Kit 990C0-88162-KIT	**	2" Gauge Kit 990C0-88150-KIT 34011-89L01-000	**
1 4" SMIS Multi-Function Gauge	990C0-88161-000 011	1	1	1	-	-
2 2" SMIS Multi-Function Gauge	990C0-88150-000 012	-	-	-	1	1
3 Terminator Female	36665-88L00-000 023	1	-	-	1	-
4 Terminator Male	36665-88L10-000 024	1	-	-	1	-
5 Extension Cable 25 feet	36662-88L00-000	-	-	-	1	-
6 Engine Interface Unit	990C0-88147-000 015	1	1	1	1	1
7 SMIS Power Cable	36663-88L00-000 020	1	1	1	1	1
8 SMIS Adapter	990C0-88136-000 016 OR 36660-89L00-000	-	-	-	1	-
9 Operation & Installation Manual for 4" Gauge		1	-	-	-	-
10 Operation & Installation Manual for 2" Gauge		-	-	-	1	-

** Quantity of T-connector(s) in a kit

OPTIONAL INSTRUMENT TRIM

Change the standard gray bezel to suit your application. Two different bezel finishes are available for 2" or 4" Multi-Function gauges.



The image shows 4" bezel, "chrome", 34193-88L00-000.

4" bezel, chrome
34193-88L00-000

4" bezel, white
34193-88L20-000

2" bezel, chrome
34193-88L40-000

2" bezel, white
34193-88L60-000

SUZUKI MODULAR INSTRUMENT SYSTEM

ENGINE INTERFACE UNIT WITH A T-CONNECTOR



990C0-88147-000 **015**

SMIS ADAPTER



990C0-88136-000 **016**

for 40AT-250T/Z with analog gauge system to add on digital gauges. 1.8m

36660-89L00-000

for DF9.9B/15A/20A with analog gauge system to add on digital gauges. 7.1m

POWER CABLE

The fused (3A) lead connects the extension cable to the power source.

SMIS POWER CABLE WITH A T-CONNECTOR



36663-88L00-000 **020**

POWER NODE WITH A T-CONNECTOR



990C0-88130-000 **021**

Allows network to be powered from multiple power sources (key switch, accessory switch, etc...). For multiple (2 or 3) engines of DF9.9BR/15AR/20AR/40A-250T/Z

ENGINE INTERFACE

The most important part of the SMIS data system. DF150TG/ZG/175TG/ZG/250AP/300AP connect to the system, using Engine Interface Adapter.

ENGINE INTERFACE ADAPTER



36661-98J10-000 **017**

for single DF150TG/ZG/175TG/ZG/250AP/300AP



36661-98J20-000 **018**

for dual DF150TG/ZG/175TG/ZG/250AP/300AP



36661-98J30-000 **019**

for triple DF150TG/ZG/175TG/ZG/250AP/300AP

CONNECTION HARDWARE

T-CONNECTOR



990C0-88110-000 **022**

T-connectors link all compatible cables, data and sensor devices, and can be easily secured.

TERMINATOR FEMALE



36665-88L00-000 **023**

120-ohm terminators are required for any open cable ends in the system.

TERMINATOR MALE



36665-88L10-000 **024**

120-ohm terminators are required for any open cable ends in the system.

ADAPTER HARNESS TO N NETWORK



990C0-88029-000 **025**

(Black network to blue devices) Allows connection to other NMEA devices (Device NET).

ADAPTER HARNESS TO L NETWORK



36666-88L10-000 **026**

(Blue network to black devices)

SENSORS

FLUID LEVEL SENSOR WITH A T-CONNECTOR



990C0-88116-000 027

Monitors the fluid levels such as fuel, live well water level, etc. 10ft cable.

WATER TEMPERATURE SENSOR WITH A T-CONNECTOR



34455-88L00-000 029

Surface-water temperature sensor. 10ft cable.

WATER PRESSURE SENSOR WITH A T-CONNECTOR



34960-88L00-000 031

SPEED SENSOR WITH A T-CONNECTOR



34190-88L00-000 028

Paddle wheel-type speed sensor. 10ft cable.



34455-88L10-000 030

(Thru-Hull type)



990C0-88120-000 032

Displays the accurate location and speed on multi-function gauges.

CONNECTION CABLE

The extension cable is the main line of SMIS. Data communication runs the length of the boat, capped at each end with a 120-ohm terminator. NMEA2000® compatible sensors or other devices can be added by the use of T-connectors throughout the system.

EXTENSION CABLE



990C0-88104-000

2 feet

36662-88L30-000

15 feet

36662-88L20-000 033

6 feet

36662-88L00-000

25 feet



NOTE: (*1): The required or recommended quantities are shown.
 (*2): While some of SMIS items have a T-connector in may be short to the required quantity.
 (*3): SMIS adapter is required only for DF9.9B/15A/20A.

Example of Connection for DF150TG/ZG/175TG/ZG/250AP/300AP with SMIS Multi-Function Gauge

(in case of equipping the same quantities of 4" and 2" gauges as engines and stations, and all optional items)

category	Ref. #	part name	Number of T-connector Included	Contents of Gauge Kit		1	2	3
				4"	2"	1	1	1
SMIS multi-function gauge	①	4" SMIS Multi-Function Gauge with a gray bezel	1	1		1	2	3
		4" Gauge Kit	3	KIT				
engine interface	②	2" SMIS Multi-Function Gauge with a gray bezel	1		1	1	2	3
	③	Engine Interface unit	1	1	1	1	2	3
		Engine Interface Adapter for single	0			1		
④		Engine Interface Adapter for dual	0				1	
		Engine Interface Adapter for triple	0					1
power cable	⑤	Power Cable	1	1	1	1	1	1
connection cable	⑥	Extension Cable 2 feet	0					
		Extension Cable 6 feet	0					
		Extension Cable 15 feet	0			1	2	3
		Extension Cable 25 feet	0	0	1			
connection hardware	⑦	T-Connector (*2)	1	3	3	4 (*2)	7 (*2)	10 (*2)
	⑧	Terminator Female	0	1	1	1	1	1
	⑨	Terminator Male	0	1	1	1	1	1
		Adapter Harness to N network (Black network to Blue devices)	0					
		Adapter Harness to L network (Blue network to Black devices)	0					
sensor		Fluid Level Sensor	1			(1)	(1)	(1)
		Speed Sensor	1			(1)	(1)	(1)
		Water Temperature Sensor	1			(1)	(1)	(1)
		Water Temperature Sensor (Thru-Hull type)	1			(1)	(1)	(1)
		Water Pressure Sensor	1			(1)	(1)	(1)
		GPS Receiver Module	1			(1)	(1)	(1)
optional trim		4" bezel, chrome	0					
		4" bezel, white	0					
		2" bezel, chrome	0					
		2" bezel, white	0					

Example of Connection for DF9.9BR/15AR/20AR/40A-250 with SMIS Multi-Function Gauge

(in case of equipping the same quantities of 4" and 2" gauges as engines' and stations', and all optional items)

category	Ref. #	part name	Number of T-connector Included	Contents of Gauge Kit		1	2	3
				4"	2"	1	1	1
SMIS multi-function gauge	①	4" SMIS Multi-Function Gauge with a gray bezel	1	1		1	2	3
		4" Gauge Kit	3	KIT				
engine interface	②	2" SMIS Multi-Function Gauge with a gray bezel	1		1	1	2	3
power cable	③	Engine Interface unit	1	1	1	1	2	3
	⑤	Power Cable	1	1	1	1	1	1
	⑩	Power Node for multiple engine of DF40-250 only	1				1	1
connection cable	⑥	Extension Cable 2 feet	0					
		Extension Cable 6 feet	0					
		Extension Cable 15 feet	0			1	2	3
		Extension Cable 25 feet	0	0	1			
connection hardware	⑦	T-Connector (*2)	1	3	3	4 (*2)	7 (*2)	10 (*2)
	⑧	Terminator Female	0	1	1	1	1	1
	⑨	Terminator Male	0	1	1	1	1	1
		Adapter Harness to N network (Black network to Blue devices)	0					
		Adapter Harness to L network (Blue network to Black devices)	0					
sensor		Fluid Level Sensor	1			(1)	(1)	(1)
		Speed Sensor	1			(1)	(1)	(1)
		Water Temperature Sensor	1			(1)	(1)	(1)
		Water Temperature Sensor (Thru-Hull type)	1			(1)	(1)	(1)
		Water Pressure Sensor	1			(1)	(1)	(1)
		GPS Receiver Module	1			(1)	(1)	(1)
optional trim		4" bezel, chrome	0					
		4" bezel, white	0					
		2" bezel, chrome	0					
		2" bezel, white	0					
adapter cable	⑪	SMIS adapter (*3)	0			1	2	3

Numbers in round-parentheses show the required ones if equipped.
the package, the total number of the T-connectors enclosed in them

engine(s)									part number
1			2			3			
station(s)									
2		2		2		2		2	
total	1st	2nd	total	1st	2nd	total	1st	2nd	
required quantity per boat (*1)									
2	1	1	4	2	2	6	3	3	990C0-88161-000
									990C0-88162-KIT
2	1	1	4	2	2	6	3	3	990C0-88150-000
1	1		2	2		3	3		990C0-88147-000
1	1								36661-98J10-000
			1	1					36661-98J20-000
						1	1		36661-98J30-000
1	1		1	1		1	1		36663-88L00-000
									990C0-88104-000
2	1	1	3	2	1	4	3	1	36662-88L20-000
									36662-88L30-000
									36662-88L00-000
6 (*2)	4	2	11 (*2)	7	4	16 (*2)	10	6	990C0-88110-000
1		1	1		1	1		1	36665-88L00-000
1	1		1	1		1	1		36665-88L10-000
									990C0-88029-000
									36666-88L10-000
(1)			(1)			(1)			990C0-88116-000
(1)			(1)			(1)			34190-88L00-000
(1)			(1)			(1)			34455-88L00-000
(1)			(1)			(1)			34455-88L10-000
(1)			(1)			(1)			34960-88L00-000
(1)			(1)			(1)			990C0-88120-000
									34193-88L00-000
									34193-88L20-000
									34193-88L40-000
									34193-88L60-000

**SINGLE ENGINE
DF150TG/ZG/
175TG/ZG/
250AP/300AP**

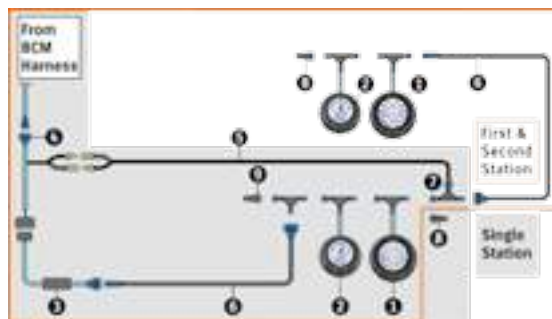

**DUAL ENGINE OF
DF150TG/ZG/
175TG/ZG/
250AP/300AP**

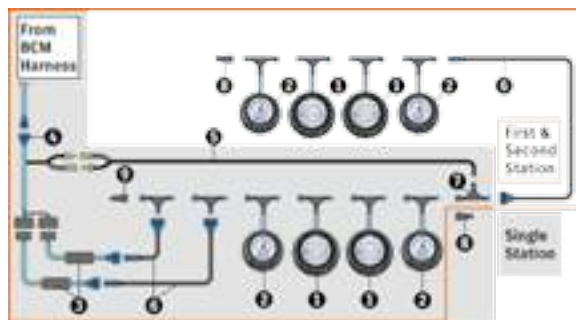

**TRIPLE ENGINE OF
DF150TG/ZG/
175TG/ZG/
250AP/300AP**

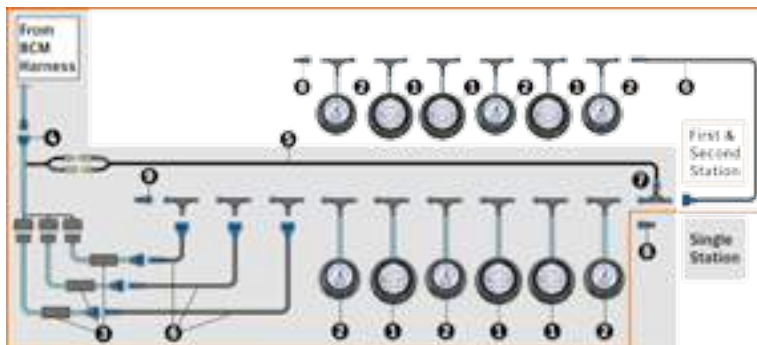

**SINGLE ENGINE OF
DF9.9BR/15AR/
20AR/40A-250**

(*3)

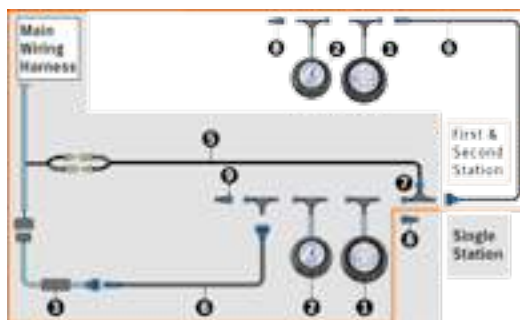
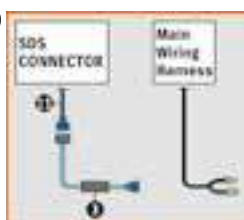

**DUAL ENGINE OF
DF9.9BR/15AR/
20AR/40A-250**

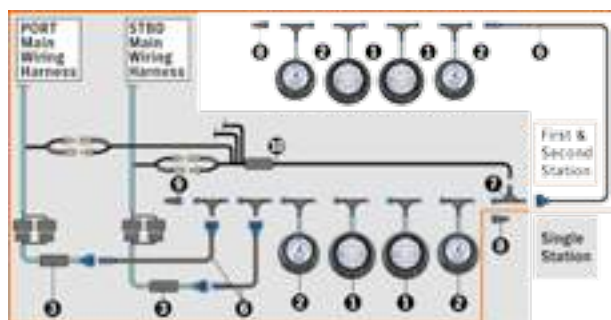

**TRIPLE
ENGINE OF
DF9.9BR/15AR/
20AR/40A-250**

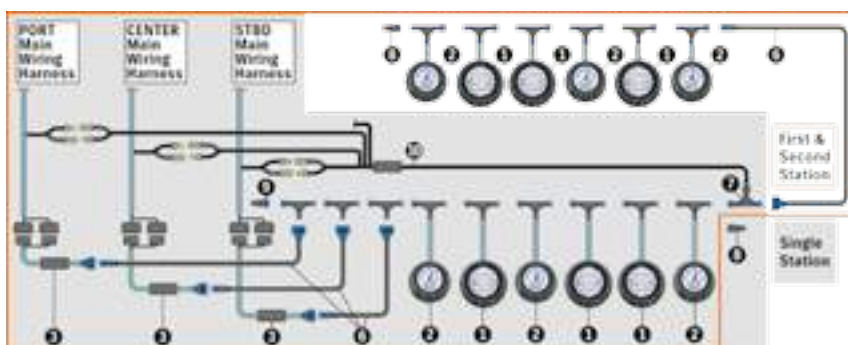

○ : Single Station □ : First & Second Station

engine(s)									part number
1			2			3			
station(s)									
2		2		2		2		2	
total	1st	2nd	total	1st	2nd	total	1st	2nd	
required quantity per boat (*1)									
2	1	1	4	2	2	6	3	3	990C0-88161-000
									990C0-88162-KIT
2	1	1	4	2	2	6	3	3	990C0-88150-000
1	1		2	2		3	3		990C0-88147-000
1	1		1	1		1	1		36663-88L00-000
			1	1		1	1		990C0-88130-000
									990C0-88104-000
2	1	1	3	2	1	4	3	1	36662-88L20-000
									36662-88L30-000
									36662-88L00-000
6 (*2)	4	2	11 (*2)	7	4	16 (*2)	10	6	990C0-88110-000
1		1	1		1	1		1	36665-88L00-000
1	1		1	1		1	1		36665-88L10-000
									990C0-88029-000
									36666-88L10-000
(1)			(1)			(1)			990C0-88116-000
(1)			(1)			(1)			34190-88L00-000
(1)			(1)			(1)			34455-88L00-000
(1)			(1)			(1)			34455-88L10-000
(1)			(1)			(1)			34960-88L00-000
(1)			(1)			(1)			990C0-88120-000
									34193-88L00-000
									34193-88L20-000
									34193-88L40-000
									34193-88L60-000
1	1		2	2		3	3		36660-89L00-000

ANALOG INSTRUMENT



Caution lamp	Caution type
CHECK ENGINE	Low battery-voltage or Other cautions on S.D.S
TEMP	Overheat (Over-revolution)
OIL	Low oil-pressure (Over-revolution) Oil change reminder
REV LIMIT	Over-revolution

TACHOMETER



34200-93J11-000 034

Gauge Size	4"
Background	White
Applicable Model	DF40AT-140AT/Z/150T/Z/ 175T/Z/200T/Z-250T/Z

Caution systems alert with a monitor lamp lighting on when an abnormal engine condition occurs. Refer to SERVICE MANUAL for the detail.



34200-93J50-000 036

Gauge Size	4"
Background	White
Applicable Model	DF40AT-140AT/Z

Exclusive for SUZUKI Troll Mode System. Automatically switches to low RPM scale when the SUZUKI Troll Mode System is activated.



34200-93J31-000 038

Gauge Size	4"
Background	White
Applicable Model	DF8AR/9.9AR/9.9BR/15AR/ 20AR/25R,DT30R/40WR

Full-scale 7000-RPM TACHOMETER can be used on electric-start models by using 4, 6 or 12 pole switch on rear of meter.



34200-93J00-000 035

Gauge Size	4"
Background	Black
Applicable Model	DF40AT-140AT/Z/150T/Z/ 175T/Z/200T/Z-250T/Z

Caution systems alert with a monitor lamp lighting on when an abnormal engine condition occurs. Refer to SERVICE MANUAL for the detail.



34200-93J40-000 037

Gauge Size	4"
Background	Black
Applicable Model	DF40AT-140AT/Z

Exclusive for SUZUKI Troll Mode System. Automatically switches to low RPM scale when the SUZUKI Troll Mode System is activated.



34200-93J20-000 039

Gauge Size	4"
Background	Black
Applicable Model	DF8AR/9.9AR/9.9BR/15AR/ 20AR/25R,DT30R/40WR

Full-scale 7000-RPM TACHOMETER can be used on electric-start models by using 4, 6 or 12 pole switch on rear of meter.

SPEEDOMETER



34100-93J11-000 040

Gauge Size	4"
Background	White
Maximum Speed	130km/h, 80mph
Applicable Model	DF40AT-140AT/Z/150T/Z/ 175T/Z/200T/Z-250T/Z

Bourdon-tube type speedometer with readings in km/h and mph. Includes vinyl tube, hardware and installation manual.



34100-93J31-000 043

Gauge Size	4"
Background	White
Maximum Speed	80km/h, 50mph
Applicable Model	DF8AR-140AT/Z/150T/Z/ 175T/Z/200T/Z-250T/ Z,DT30R/40WR

Bourdon-tube type speedometer with readings in km/h and mph. Includes vinyl tube, hardware and installation manual.



34100-93J51-000 045

Gauge Size	4"
Background	White
Maximum Speed	80km/h, 45knots
Applicable Model	DF8AR-140AT/Z/150T/Z/ 175T/Z/200T/Z-250T/ Z,DT30R/40WR

Bourdon-tube type speedometer with readings in km/h and mph. Includes vinyl tube, hardware and installation manual.



34100-93J00-000 041

Gauge Size	4"
Background	Black
Maximum Speed	130km/h, 80mph
Applicable Model	DF40AT-140AT/Z/150T/Z/ 175T/Z/200T/Z-250T/Z

Bourdon-tube type speedometer with readings in km/h and mph. Includes vinyl tube, hardware and installation manual.



34100-93J20-000 044

Gauge Size	4"
Background	Black
Maximum Speed	80km/h, 50mph
Applicable Model	DF8AR-140AT/Z/150T/Z/ 175T/Z/200T/Z-250T/ Z,DT30R/40WR

Bourdon-tube type speedometer with readings in km/h and mph. Includes vinyl tube, hardware and installation manual.



34100-93J40-000 046

Gauge Size	4"
Background	Black
Maximum Speed	80km/h, 45knots
Applicable Model	DF8AR-140AT/Z/150T/Z/ 175T/Z/200T/Z-250T/ Z,DT30R/40WR

Bourdon-tube type speedometer with readings in km/h and mph. Includes vinyl tube, hardware and installation manual.



34100-93J60-000 042

Gauge Size	4"
Background	White
Maximum Speed	120km/h, 65knots
Applicable Model	DF40AT-140AT/Z/150T/Z/ 175T/Z/200T/Z-250T/Z

Bourdon-tube type speedometer with readings in km/h and knots. Includes vinyl tube, hardware and installation manual.

WATER-PRESSURE-SENSOR KIT

34970-98J02-000 047

Applicable Model DF70AT-90AT/300T/Z

This kit can be installed as a water pressure sensor or as a speed sensor. The detail is described in the installation manual, which is contained in the package.



Contents:	Quantity		
	in KIT	used for water pressure sensor	used for speed sensor
1 Sensor	1	1	1
2 Connector	1	1	1
3 Bolt	1	1	1
4 Clip	4	4	1
5 3way	1	1	-
6 Water pressure hose (500mm)	1	1	-
7 Cap	1	-	1

ANALOG INSTRUMENT



SPEEDOMETER SENDER ASSY



34190-95500-000 048

Applicable Model DF9.9BT-20AT/25R/40AT-300AP, DT30R/40WR



34190-87D00-000 049

Applicable Model DF9.9BT-20AT/25R/40AT-140AT/Z/150T/Z/175T/Z/200T/Z-250T/Z, DT30R/40WR

SPEEDOMETER-SUB KIT

34120-98J01-000 050

Applicable Model DF70AT-90AT/300T/Z



Contents	Part number	Qty/kit
SPEEDOMETER SENDER	34190-95500-000 048	1
SPEEDOMETER-HOSE UNION	55127-87D00-000	1
HOSE		1
Contents	Part number	Qty/kit
CLAMP (L: 100 mm)	09407-10404-000	2

Use SPEEDOMETER SENDER (34190-95500-000) in case that the integrated sender cannot detect a proper boat speed.

TRIM GAUGE



34800-93J11-000 051

Gauge Size 2"

Background White

Applicable Model DF40AT-140AT/Z/150T/Z/175T/Z/200T/Z-250T/Z

Magnetic-type gauge shows trim angle for optimum performance and efficiency.



34800-93J00-000 052

Gauge Size 2"

Background Black

Applicable Model DF40AT-140AT/Z/150T/Z/175T/Z/200T/Z-250T/Z

Magnetic-type gauge shows trim angle for optimum performance and efficiency.

FUEL GAUGE



34300-93J11-000 053

Gauge Size 2"

Background White

Applicable Model DF8AR-140AT/Z/150T/Z/175T/Z/200T/Z-250T/Z, DT30R/40WR

FUEL GAUGE alone works with the US Standard 2500 sending unit. Use the 150Q adapter to connect the gauge to a European standard sending unit.



34300-93J00-000 054

Gauge Size 2"

Background Black

Applicable Model DF8AR-140AT/Z/150T/Z/175T/Z/200T/Z-250T/Z, DT30R/40WR

FUEL GAUGE alone works with the US Standard 2500 sending unit. Use the 150Q adapter to connect the gauge to a European standard sending unit.

HOURLY METER



34500-93J11-000 055

Gauge Size	2"
Background	White
Applicable Model	DF8AR-140AT/Z/150T/Z/ 175T/Z/200T/Z-250T/ Z,DT30R/40WR

12-volt-electric-motor-driven meter indicates hours that your outboard motor has been operated in order for you to know when each periodic service is required.



34500-93J00-000 056

Gauge Size	2"
Background	Black
Applicable Model	DF8AR-140AT/Z/150T/Z/ 175T/Z/200T/Z-250T/ Z,DT30R/40WR

12-volt-electric-motor-driven meter indicates hours that your outboard motor has been operated in order for you to know when each periodic service is required.

VOLTMETER



34600-93J11-000 057

Gauge Size	2"
Background	White
Applicable Model	DF8AR-140AT/Z/150T/Z/ 175T/Z/200T/Z-250T/ Z,DT30R/40WR

To help your SUZUKI OUTBOARD MOTOR run at its best, monitor the charging system functioning with a VOLTMETER.



34600-93J00-000 058

Gauge Size	2"
Background	Black
Applicable Model	DF8AR-140AT/Z/150T/Z/ 175T/Z/200T/Z-250T/ Z,DT30R/40WR

To help your SUZUKI OUTBOARD MOTOR run at its best, monitor the charging system functioning with a VOLTMETER.

WATER-PRESSURE GAUGE



34650-93J31-000 059

Gauge Size	2"
Background	White
Applicable Model	DF40AT-140AT/Z/150T/Z/ 175T/Z/200T/Z-250T/Z

Bourdon-tube type gauge measures cooling-water pressure. Select an appropriate INSTALLATION KIT for each model.



34650-93J20-000 060

Gauge Size	2"
Background	Black
Applicable Model	DF40AT-140AT/Z/150T/Z/ 175T/Z/200T/Z-250T/Z

Bourdon-tube type gauge measures cooling-water pressure. Select an appropriate INSTALLATION KIT for each model.

INSTALLATION KIT for WATER-PRESSURE GAUGE



34660-90J02-000

Applicable Model DF40AT-140AT/Z

34660-96J00-000

Applicable Model DF150T/Z-175T/Z

34660-93J00-000 061

Applicable Model DF200T/Z-250T/Z

KIT includes fittings and hoses needed for motor to gauge connection.

ELECTRONIC THROTTLE AND SHIFT SYSTEM

- Computerized Drive by Wire system of the Suzuki Precision Control (SPC) eliminates wiring friction losses and allows smooth and superior handling. As a result, SPC makes smooth and linear control from start and at low speed.
- By the control panel operation(included remote-control kits), you can start and stop the engine and change a steering station with multiple engines you can control the synchronization of an engine rev and change the tilt angles.
- Not only DF300A/250A, but also DF150TG/ZG, AF175TG/ZG are suitable for this system.
- Chrome plating finish for better rust resistance
- applicable to maximum 2 station and maximum 4 engines
- 8 kinds of rigging parts kits are available for your convenience to select all necessary parts for your requirements.

REMOTE-CONTROL KIT for SINGLE ENGINE

SINGLE STATION		STATION		DUAL STATION			
67000-98J08-000		BINNACLE-MOUNT CONTROL KIT or FLUSH-MOUNT CONTROL KIT Applicable Model		First Station 67000-98J08-000	+	Second Station 67000-98J18-000	
DF150TG/ZG/175TG/ ZG/250AP/300AP		Contents:		67000-98J67-000		DF150TG/ZG/175TG/ZG/250AP/300AP	
	QTY						QTY
67200-98J03-000 062	1	BINNACLE MOUNT R/C BOX or FLUSH MOUNT R/C BOX		67200-98J03-000 062	1	67200-98J03-000 062	2
67200-98J22-000 063				67200-98J22-000 063		-	
37100-98J03-000 065	1	MAIN SWITCH PANEL		37100-98J03-000 065	1	-	1
37100-98J11-000 066	1	CONTROL PANEL		37100-98J11-000 066	1	37100-98J11-000 066	2
38500-93J90-000 100	1	WARNING BUZZER		38500-93J90-000 100	1	38500-93J90-000 100	2
09407-08401-000	1	WARNING-BUZZER CLAMP		09407-08401-000	1	09407-08401-000	2
-	-	EMERGENCY SWITCH PANEL		-	-	37803-93J03-000 091	1
36625-98J10-000 078	1	BATTERY LEAD		36625-98J10-000 078	1	-	1
36770-98J10-000 069	1	BOAT CONTROL MODULE (BCM)		36770-98J10-000 069	1	36770-98J10-000 069	2
36775-98J00-000 070	1	BCM HOLDER (L)		36775-98J00-000 070	1	36775-98J00-000 070	2
36776-98J00-000 071	1	BCM HOLDER (R)		36776-98J00-000 071	1	36776-98J00-000 071	2
33911-88BLO-000 072	1	BCM-CONNECT CAP		33911-88BLO-000 072	1	33911-88BLO-000 072	2
33925-93J00-000 073	1	BCM CUSHION		33925-93J00-000 073	1	33925-93J00-000 073	2
36623-98J20-000 080	1	BCM #1 WIRING HARNESS		36623-98J20-000 080	1	-	1
-	-	BCM #2 WIRING HARNESS		-	-	36624-98J02-000 081	1
33926-98J00-000 079	2	TERMINAL RESISTOR		33926-98J00-000 079	2	-	2
-	-	ENGINE WIRING HARNESS		-	-	-	-
-	-	DUAL-STATION WIRING HARNESS		-	-	36622-98J00-000 077	1
09403-13402-000	10	HARNESS CLAMP		09403-13402-000	10	09403-13402-000	20
37860-87L00-000 095	1	TROLL MODE SWITCH PANEL		37860-87L00-000 095	1	37860-87L00-000 095	2

REMOTE-CONTROL KIT for DUAL ENGINE

SINGLE STATION		STATION		DUAL STATION			
67000-98J28-000		BINNACLE-MOUNT CONTROL KIT or FLUSH-MOUNT CONTROL KIT Applicable Model		First Station 67000-98J28-000	+	Second Station 67000-98J38-000	
DF150TG/ZG/175TG/ ZG/250AP/300AP		Contents:		67000-98J67-000		DF150TG/ZG/175TG/ZG/250AP/300AP	
	QTY						QTY
67200-98J13-000 064	1	BINNACLE MOUNT R/C BOX or FLUSH MOUNT R/C BOX		67200-98J13-000 064	1	67200-98J13-000 064	2
37100-98J03-000 065	1	MAIN SWITCH PANEL		37100-98J03-000 065	1	-	1
37100-98J21-000 067	1	CONTROL PANEL		37100-98J21-000 067	1	37100-98J21-000 067	2
38500-93J90-000 100	1	WARNING BUZZER		38500-93J90-000 100	1	38500-93J90-000 100	2
09407-08401-000	1	WARNING-BUZZER CLAMP		09407-08401-000	1	09407-08401-000	2
-	-	EMERGENCY SWITCH PANEL		-	-	37803-93J03-000 091	1
36625-98J10-000 078	1	BATTERY LEAD		36625-98J10-000 078	1	-	1
36770-98J10-000 069	1	BOAT CONTROL MODULE (BCM)		36770-98J10-000 069	1	36770-98J10-000 069	2
36775-98J00-000 070	1	BCM HOLDER (L)		36775-98J00-000 070	1	36775-98J00-000 070	2
36776-98J00-000 071	1	BCM HOLDER (R)		36776-98J00-000 071	1	36776-98J00-000 071	2
-	-	BCM-CONNECT CAP		-	-	-	-
33925-93J00-000 073	1	BCM CUSHION		33925-93J00-000 073	1	33925-93J00-000 073	2
36623-98J30-000	1	BCM #1 WIRING HARNESS		36623-98J30-000	1	-	1
-	-	BCM #2 WIRING HARNESS		-	-	36624-98J11-000	1
33926-98J00-000 079	2	TERMINAL RESISTOR		33926-98J00-000 079	2	-	2
36621-98J00-000 076	1	ENGINE WIRING HARNESS		36621-98J00-000 076	1	-	1
-	-	DUAL-STATION WIRING HARNESS		-	-	36622-98J00-000 077	1
09403-13402-000	15	HARNESS CLAMP		09403-13402-000	15	09403-13402-000	25
37860-87L00-000 095	1	TROLL MODE SWITCH PANEL		37860-87L00-000 095	1	37860-87L00-000 095	2



062



063



064

REMOTE-CONTROL KIT for TRIPLE ENGINE

SINGLE STATION		STATION		DUAL STATION					
67000-98J48-000		BINNACLE-MOUNT CONTROL KIT or FLUSH-MOUNT CONTROL KIT Applicable Model		First Station 67000-98J48-000		Second Station 67000-98J58-000			
DF150TG/ZG/175TG/ ZG/250AP/300AP		Contents:		DF150TG/ZG/175TG/ZG/250AP/300AP		DF150TG/ZG/175TG/ZG/250AP/300AP			
QTY							QTY		
67200-98J13-000	064	BINNACLE MOUNT R/C BOX	1	67200-98J13-000	064	67200-98J13-000	064	1	2
-	-	or	-	-	-	-	-	-	-
37100-98J03-000	065	FLUSH MOUNT R/C BOX	1	37100-98J03-000	065	37100-98J03-000	065	1	1
37100-98J31-000	068	MAIN SWITCH PANEL	1	37100-98J31-000	068	37100-98J31-000	068	1	2
38500-93J90-000	100	CONTROL PANEL	1	38500-93J90-000	100	38500-93J90-000	100	1	2
09407-08401-000	1	WARNING BUZZER	1	09407-08401-000	1	09407-08401-000	1	1	2
-	-	WARNING-BUZZER CLAMP	1	-	-	37803-93J03-000	91	1	1
36625-98J10-000	078	EMERGENCY SWITCH PANEL	1	36625-98J10-000	078	-	-	-	-
36770-98J10-000	069	BATTERY LEAD	1	36770-98J10-000	069	36770-98J10-000	069	1	2
36775-98J00-000	070	BOAT CONTROL MODULE (BCM)	1	36775-98J00-000	070	36775-98J00-000	070	1	2
36776-98J00-000	071	BCM HOLDER (L)	1	36776-98J00-000	071	36776-98J00-000	071	1	2
-	-	BCM HOLDER (R)	1	-	-	-	-	-	-
33925-93J00-000	073	BCM-CONNECT CAP	1	33925-93J00-000	073	33925-93J00-000	073	1	2
36623-98J30-000	1	BCM CUSHION	1	36623-98J30-000	1	-	-	-	-
-	-	BCM #1 WIRING HARNESS	1	-	-	36624-98J11-000	1	1	1
33926-98J00-000	079	BCM #2 WIRING HARNESS	2	33926-98J00-000	079	-	-	-	-
36621-98J10-000	1	TERMINAL RESISTOR	2	36621-98J10-000	1	-	-	-	-
-	-	ENGINE WIRING HARNESS	1	-	-	36622-98J00-000	077	1	1
09403-13402-000	18	DUAL-STATION WIRING HARNESS	1	09403-13402-000	18	09403-13402-000	10	28	28
37860-87L00-000	095	HARNESS CLAMP	1	37860-87L00-000	095	37860-87L00-000	095	1	2
		TROLL MODE SWITCH PANEL	1						

REMOTE-CONTROL KIT for QUADRUPL ENGINE

SINGLE STATION		STATION		DUAL STATION					
67000-98J70-000		BINNACLE-MOUNT CONTROL KIT or FLUSH-MOUNT CONTROL KIT Applicable Model		First Station 67000-98J70-000		Second Station 67000-98J80-000			
DF150TG/ZG/175TG/ ZG/250AP/300AP		Contents:		DF150TG/ZG/175TG/ZG/250AP/300AP		DF150TG/ZG/175TG/ZG/250AP/300AP			
QTY							QTY		
67200-98J13-000	064	BINNACLE MOUNT R/C BOX	1	67200-98J13-000	064	67200-98J13-000	064	1	2
-	-	or	-	-	-	-	-	-	-
37100-98J03-000	065	FLUSH MOUNT R/C BOX	1	37100-98J03-000	065	37100-98J03-000	065	1	1
37100-98J21-000	067	MAIN SWITCH PANEL	1	37100-98J21-000	067	37100-98J21-000	067	2	4
38500-93J90-000	100	CONTROL PANEL	2	38500-93J90-000	100	38500-93J90-000	100	2	4
09407-08401-000	2	WARNING BUZZER	2	09407-08401-000	2	09407-08401-000	2	2	4
-	-	WARNING-BUZZER CLAMP	2	-	-	37803-93J03-000	089	1	1
36625-98J10-000	078	EMERGENCY SWITCH PANEL	2	36625-98J10-000	078	-	-	-	-
36770-98J20-000	2	BATTERY LEAD	2	36770-98J20-000	2	36770-98J20-000	2	2	4
36775-98J00-000	070	BOAT CONTROL MODULE (BCM)	2	36775-98J00-000	070	36775-98J00-000	070	2	4
36776-98J00-000	071	BCM HOLDER (L)	2	36776-98J00-000	071	36776-98J00-000	071	2	4
-	-	BCM HOLDER (R)	2	-	-	-	-	-	-
33925-93J00-000	073	BCM-CONNECT CAP	2	33925-93J00-000	073	33925-93J00-000	073	2	4
36623-98J40-000	1	BCM CUSHION	2	36623-98J40-000	1	36623-98J40-000	1	2	2
-	-	BCM #1 WIRING HARNESS	1	-	-	-	-	-	-
33926-98J00-000	079	BCM #2 WIRING HARNESS	4	33926-98J00-000	079	-	-	-	-
36621-98J00-000	076	TERMINAL RESISTOR	2	36621-98J00-000	076	-	-	-	-
-	-	ENGINE WIRING HARNESS	2	-	-	36622-98J00-000	2	2	2
09403-13402-000	20	DUAL-STATION WIRING HARNESS	20	09403-13402-000	20	09403-13402-000	15	35	35
37860-87L00-000	095	HARNESS CLAMP	1	37860-87L00-000	095	37860-87L00-000	095	1	2
		TROLL MODE SWITCH PANEL	1						

SUZUKI PRECISION CONTROL ELECTRONIC THROTTLE AND SHIFT SYSTEM

MAIN SWITCH PANEL



37100-98J03-000 065

Single ignition with Emergency-stop switch

Applicable Model DF150TG/ZG/175TG/ZG/250AP/300AP

CONTROL PANEL



37100-98J11-000 066

for Single-Engine

Applicable Model DF150TG/ZG/175TG/ZG/250AP/300AP



37100-98J21-000 067

for Dual-Engine

Applicable Model DF150TG/ZG/175TG/ZG/250AP/300AP



37100-98J31-000 068

for Triple-Engine

Applicable Model DF150TG/ZG/175TG/ZG/250AP/300AP

BOAT CONTROL MODULE (BCM)



36770-98J10-000 069

Applicable Model DF150TG/ZG/175TG/ZG/250AP/300AP

36770-98J20-000

for Quadruple engines

Applicable Model DF150TG/ZG/175TG/ZG/250AP/300AP

BCM HOLDER (L/R)



36775-98J00-000 070

Applicable Model DF150TG/ZG/175TG/ZG/250AP/300AP

36776-98J00-000 071

Applicable Model DF150TG/ZG/175TG/ZG/250AP/300AP

BCM-CONNECT CAP



33911-88B10-000 072

Applicable Model DF150TG/ZG/175TG/ZG/250AP/300AP

BCM CUSHION



33925-93J00-000 073

Applicable Model DF150TG/ZG/175TG/ZG/250AP/300AP

CONNECTION BETWEEN ENGINE AND CONTROL SYSTEM

MAIN WIRING HARNESS



36620-98J30-000 074

6.5 meters for control system

Applicable Model DF150TG/ZG/175TG/ZG/250AP/300AP

36620-98J40-000

9.5 meters for control system

Applicable Model DF150TG/ZG/175TG/ZG/250AP/300AP

MAIN-WIRING-HARNESS EXTENSION



36620-98J50-000 075

2.0 meters for control system

Applicable Model DF150TG/ZG/175TG/ZG/250AP/300AP

ENGINE WIRING HARNESS



36621-98J00-000 076

for Dual engines

Applicable Model DF150TG/ZG/175TG/ZG/250AP/300AP

36621-98J10-000

for Triple engines

Applicable Model DF150TG/ZG/175TG/ZG/250AP/300AP

DUAL-STATION WIRING HARNESS



36622-98J00-000 077

for Dual-station control system

Applicable Model DF150TG/ZG/175TG/ZG/250AP/300AP

BATTERY LEAD



36625-98J10-000 078

6.5 meters

Applicable Model DF150TG/ZG/175TG/ZG/250AP/300AP

TERMINAL RESISTOR



33926-98J00-000 079

Applicable Model DF150TG/ZG/175TG/ZG/250AP/300AP



BCM #1 WIRING HARNESS



36623-98J20-000 080

for Single engine and Single (First) station

Applicable Model DF150TG/ZG/175TG/ZG/250AP/300AP

36623-98J30-000

for Dual or Triple engines and Single (First) station

Applicable Model DF150TG/ZG/175TG/ZG/250AP/300AP

36623-98J40-000

for Quadruple engines

Applicable Model DF150TG/ZG/175TG/ZG/250AP/300AP

BCM #2 WIRING HARNESS



36624-98J02-000 081

for Single engine and Second station

Applicable Model DF150TG/ZG/175TG/ZG/250AP/300AP

36624-98J11-000

for Dual or Triple engines and Second station

Applicable Model DF150TG/ZG/175TG/ZG/250AP/300AP

MECHANICAL REMOTE CONTROL SYSTEM

REMOTE-CONTROL KIT for SINGLE ENGINE + SINGLE STATION

67000-93J04-000	67000-93J47-000	-
-	-	67000-93J25-000
-	-	-
DF9.9B-140AT/Z/150T/Z/175T/ Z/200T/Z-250T/Z	DF40AT-140AT/Z/150T/Z/175T/ Z/200T/Z-250T/Z	DF40AT-140AT/Z/150T/Z/175T/ Z/200T/Z-250T/Z
67200-93J13-000 ⁰⁸²	67200-93J13-000 ⁰⁸²	-
-	-	67200-93J32-000 ⁰⁸⁴
-	-	-
-	34200-93J11-000 ⁰³⁴	-
-	34800-93J11-000 ⁰⁵¹	-
-	36620-93J02-000 ⁰⁸⁸	-
-	-	-
37100-96J23-000 ⁰⁹³	37100-96J23-000 ⁰⁹³	37100-96J23-000 ⁰⁹³

BINNACLE-MOUNT REMOTE CONTROL BOX



67200-93J13-000 ⁰⁸²

Single-engine

Applicable Model DF8AR-140AT/Z/150T/Z/
175T/Z/200T/Z-250T/Z

BINNACLE-MOUNT REMOTE CONTROL BOX



67200-93J23-000 ⁰⁸³

Dual-engine

Applicable Model DF100A-140AT/Z/150T/Z/
175T/200T/Z-250T/Z

FLUSH-MOUNT REMOTE CONTROL BOX



67200-93J32-000 ⁰⁸⁴

Single-engine

Applicable Model DF25R-140AT/Z/150T/Z/
175T/Z/200T/Z-250T/Z

SPACER KIT for REMOTE CONTROL BOX



67500-93J00-000 ⁰⁸⁶

for Single Binnacle-mount type

Applicable Model DF8AR-140AT/Z/150T/Z/
175T/Z/200T/Z-250T/Z



67500-93J10-000 ⁰⁸⁷

for Dual Binnacle-mount type

Applicable Model DF100A-140AT/Z/150T/Z/
175T/200T/Z-250T/Z



**REMOTE-CONTROL KIT for
DUAL ENGINE + SINGLE STATION**

				BINNACLE-MOUNT CONTROL KIT		67000-93J14-000		67000-93J57-000		
67000-93J68-000		-		FLUSH-MOUNT CONTROL KIT		-		-		
-		67000-93J78-000		SIDE-MOUNT CONTROL KIT		-		-		
DF40AT-140AT/Z/150T/ Z/175T/Z/200T/Z-250T/Z		DF40AT-140AT/Z/150T/ Z/175T/Z/200T/Z-250T/Z		Applicable Model		DF100A-140AT/Z/150T/ Z/175T/Z/200T/Z-250T/Z		DF100A-140AT/Z/150T/ Z/175T/Z/200T/Z-250T/Z		
QTY		QTY		Contents		QTY		QTY		
-	-	-	-	BINNACLE MOUNT R/C BOX	67200-93J23-000	083	1	67200-93J23-000	083	1
67000-93J68-000	084	1	-	FLUSH MOUNT R/C BOX	-	-	-	-	-	-
-	-	-	67200-93J06-000	SIDE MOUNT R/C BOX	-	-	-	-	-	-
34200-93J11-000	034	1	34200-93J11-000	TACHOMETER (Background: White)	-	-	-	34200-93J11-000	034	2
34800-93J11-000	051	1	34800-93J11-000	TRIM GAUGE (Background: White)	-	-	-	34800-93J11-000	051	2
36620-93J02-000	088	1	36620-93J02-000	MAIN WIRING HARNESS	-	-	-	36620-93J02-000	088	2
-	-	-	-	MAIN-WIRING-HARNESS EXTENSION	-	-	-	36620-93J10-000	-	1
37100-96J23-000	093	1	-	IGNITION SWITCH PANEL	37100-96J13-000	094	1	37100-96J13-000	094	1

SIDE-MOUNT REMOTE CONTROL BOX



67200-91J04-000

Single-engine

Applicable Model DF4-6

67200-91J20-000*

Single-engine

Applicable Model DF4-6

* This item will be available in May 2014.

67200-94J15-000 085

Single-engine. With warning buzzer

Applicable Model DF8AR-20AR

67200-94J20-000*

Single-engine. With warning buzzer

Applicable Model DF8AR-20AR

67200-97E44-000

Single-engine. With warning buzzer

Applicable Model DT25K/30/R

67200-89E40-000*

Single-engine. With warning buzzer

Applicable Model DT25K/30/R

67200-93J06-000

Single-engine. With PTT switch

Applicable Model DF9.9BT/20AT/40AT-140AT/
150T/Z/175T/Z/200T/Z-250T/Z

67200-93J50-000*

Single-engine. With PTT switch

Applicable Model DDF9.9BT/20AT/40AT-140AT/
Z/150T/Z/175T/Z/200T/Z-250T/Z

**CONNECTION between ENGINE and
CONTROL SYSTEM**

MAIN WIRING HARNESS



36620-93J52-000

5.0 meters for Control system

Applicable Model DF40A-140AT/Z/150T/Z/
175T/Z/200T/Z-250T/Z

36620-93J02-000 088

6.5 meters for Control system

Applicable Model DF9.9BT/20AT/
40AT-140AT/Z/150T/
Z/175T/Z/200T/Z-250T/Z

36620-93J62-000

8.0 meters for Control system

Applicable Model DF40A-140AT/Z/150T/Z/
175T/Z/200T/Z-250T/Z

36620-94J01-000

6.5 meters for Control system without
Monitor-signal wire,
Trim-sender wire and PTT-SW wire

Applicable Model DF8AR-25R

BATTERY LEAD



36625-93J10-000 089

6.7 meters

Applicable Model DF70AT-90AT/150T/Z/175T/Z/
200T/Z-250T/Z

**MAIN-WIRING-HARNESS
EXTENSION**

36620-93J10-000

2.0 meters for Control system

Applicable Model DF9.9BR-20AT/Z/150T/Z/
175T/Z/200T/Z-250T/Z

36620-93J40-000

3.0 meters for Control system

Applicable Model DF9.9BR-20AT/R/
40AT-140AT/Z/150T/Z/
175T/Z/200T/Z-250T/Z



MECHANICAL REMOTE CONTROL SYSTEM

SWITCH PANEL



IGNITION SWITCH PANEL



37100-96J00-000 090

Single ignition

Applicable Model DF9.9BR-140AT/Z/150T/Z/
175T/Z/200T/Z-250T/Z

37100-99E00-000

Single ignition

Applicable Model DT30/R

EMERGENCY SWITCH PANEL



37803-93J03-000 091

Applicable Model DF9.9BR-300AP

37803-99E03-000

Applicable Model DT30/R

LIGHTING SWITCH PANEL



37210-93J00-000 092

Applicable Model DF9.9BR-140AT/Z/150T/Z/
175T/Z/200T/Z-250T/
Z,DT30/R/40W/WR

IGNITION SWITCH PANEL



37100-96J23-000 093

Single ignition with
Emergency-stop switch

Applicable Model DF9.9BR-140AT/Z/150T/Z/
175T/Z/200T/Z-250T/Z



37100-96J13-000 094

Dual ignition with
Emergency-stop switch

Applicable Model DF100A-140AT/Z/150T/Z/
175T/Z/200T/Z-250T/Z

TROLL MODE SWITCH PANEL



37860-87L00-000 095

Applicable Model DF40AT-140AT/Z/150TG/
ZG/175TG/ZG/250AP/300AP

Activates SUZUKI Troll Mode System and controls RPM
from idling engine speed up to 1200rpm at every 50rpm.

PTT SWITCH PANEL



37805-93J00-000 096

Applicable Model DF40AT-140AT/Z/150T/Z/
175T/Z/200T/Z-250T/Z

REMOTE CONTROL CABLE



67320-93J00-000 097

8 feet 2.44 meters

Applicable Model DF4-250T/Z, DT9.9-40WR

67320-93J10-000

10 feet 3.05 meters

Applicable Model DF4-250T/Z, DT9.9-40WR

67320-93J20-000

12 feet 3.66 meters

Applicable Model DF4-250T/Z, DT9.9-40WR

67320-93J30-000

14 feet 4.27 meters

Applicable Model DF4-250T/Z, DT9.9-40WR

67320-93J40-000

16 feet 4.88 meters

Applicable Model DF4-250T/Z, DT9.9-40WR

67320-93J50-000

18 feet 5.49 meters

Applicable Model DF4-250T/Z, DT9.9-40WR

67320-93J60-000

20 feet 6.10 meters

Applicable Model DF4-250T/Z, DT9.9-40WR

67320-93J70-000

22 feet 6.71 meters

Applicable Model DF4-250T/Z, DT9.9-40WR

67320-93J80-000

24 feet 7.32 meters

Applicable Model DF4-250T/Z, DT9.9-40WR

GENUINE REMOTE-CONTROL CABLES employ the latest in cable technology. The inner core is encased in nylon, and travels back and forth in a high-density polyethylene liner.

THRU-HULL FITTING AND HOSE KIT



990C0-20010-000 098

Single, dual, triple engine installations. One kit is necessary for each engine used. When attaching the rigging tube to the engine, adapter kit 67300-90J00-000/67300-93J00-000 is also required for each engine.

Applicable Model DF70AT-140T/Z, DF150T/Z-300T/Z (model year 2006-)

PERFORMANCE REMOTE CONTROL CABLES



99105-11002-015 099

15 feet 4.57 meters

Applicable Model DF4-250T/Z, DT9.9-40WR

99105-11002-017

17 feet 5.18 meters

Applicable Model DF4-250T/Z, DT9.9-40WR

99105-11002-019

19 feet 5.79 meters

Applicable Model DF4-250T/Z, DT9.9-40WR

99105-11002-021

21 feet 6.40 meters

Applicable Model DF4-250T/Z, DT9.9-40WR

99105-11002-023

23 feet 7.01 meters

Applicable Model DF4-250T/Z, DT9.9-40WR

99105-11002-025

25 feet 7.62 meters

Applicable Model DF4-250T/Z, DT9.9-40WR

99105-11002-027

27 feet 8.23 meters

Applicable Model DF4-250T/Z, DT9.9-40WR

PERFORMANCE REMOTE CONTROL CABLES employ a unique design that incorporates a splined core. Ridges on the core to ensure a close fit to the cable's inner liner with minimum contact, allowing the core to glide back and forth smoothly.

WARNING BUZZER



38500-93J90-000 100

Applicable Model DF9.9BR-300AP

THRU-HULL HOSE ATTACHMENT



67300-90J00-000

Applicable Model DF70A-140A

67300-93J00-000 101

Applicable Model DF150-300AP

REMOTE CONTROL ATTACHING KIT

Converts ME model to REMOTE-CONTROL model.

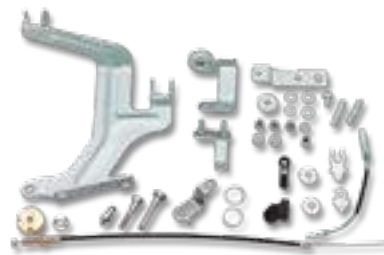

67130-91J02-000 102

Applicable Model DF4-6



67130-95J02-000 103

Applicable Model DF25

67130-99J00-000

CLAMP BRACKET SET (41100-99J00-0EP) is required for installing 67130-99J00-000.

Applicable Model DF8A/9.9A

67130-89L01-000

Applicable Model DF9.9B/15A/20A

CLAMP BRACKET SET

41100-99J00-0EP

Applicable Model DF8A/9.9A

TWIN REMOCON ATTACHMENT KIT



67140-95600-000 104

Applicable Model DT9.9B-20AT/40AT-140AT/Z/150T/Z/175T/Z/200T/Z-250T/Z, DT40W/WR/WK



STEERING



TILLER HANDLE KIT

Main features

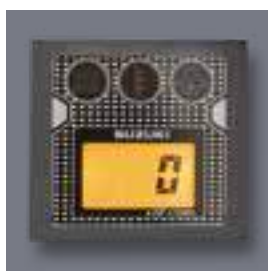

Tachometer with warning indicators

- Digital tachometer with indicators for the first time of all the tiller handles in the marine industry.
- The check pattern panel makes the digital tachometer display clearly visible.
- Reliable for the critical information from the warning indicators.
- 3 digits digital tachometer shows RPM during cruising or trolling.



Shift lever

- Round shape for comfortable grip.
- Moderate shifting feeling.



63002-88L20-0EP 105

Applicable Model DF40A/ 50A

63002-88L10-0EP 106

Applicable Model DF60A/50AV/60AV

63002-87L11-0EP 107

Applicable Model DF70A-90A

63002-90J30-0EP 108

with Adjustable Steering Damper

Applicable Model DF100A/115A



Angle adjustable bracket

- The angle adjustable bracket changes the basic handle position in three levels. That will help better handle positioning in accordance with user's boat.



Troll mode switch

- Activates SUZUKI Troll Mode System and controls RPM from idling engine speed up to 1200rpm at every 50rpm.



Power trim & tilt switch and throttle grip friction adjuster

- The PTT switch at the toe of the grip bar helps users to control the trim position and throttling at the same time.
- The throttle grip friction adjuster at the base of the grip bar supports user's throttle control.

TILLER HANDLE KIT



The conventional kits are also applicable.

63002-88L06-0EP

Applicable Model DF40A-60A

63002-87L04-0EP

Applicable Model DF70A-90A

63002-90J26-0EP

109

with adjustable steering damper

Applicable Model DF100A/115A

CONTENTS: Ignition switch, Engine-stop switches, Wiring harness, Cables and Grommets
TILLER HANDLE KITS are designed for easy installation for selected electric start models.

DUAL-ENGINE TIE-BAR



67600-90J00-000

110

Stainless steel

Applicable Model DF100A-140A

67600-93J00-000

Stainless steel

Applicable Model DF150T/Z/175T/Z/200T/
Z-250T/Z

STEERING EXTENSION KIT



67630-93J00-000

111

for installation of DUAL-ENGINE TIE-BAR
(67600-93J00-000)

Applicable Model DF150T/Z/175T/Z/200T/
Z-250T/Z

STEERING CABLE SEAL



41161-94400-000

112

Applicable Model DF8A-250T/Z,DT25K-40WR

STEERING-BRACKET ATTACHMENT



43755-95J01-000

Applicable Model DF25Q/R

Used to connect DRAG LINK.

DRAG-LINK KIT



67700-87L01-000

Applicable Model DF70A-90A

67700-93J00-000

Applicable Model DF40A-60A/200T/Z-250T/Z

67700-95J01-000

Applicable Model DF25/R/Q

67700-96J00-000

Applicable Model DF150-175

67701-87J11-000

Applicable Model DF40A-60A/200T/Z-250T/Z

67701-87L01-000

Applicable Model DF70A-90A

67701-90J00-000

Applicable Model DF100A-140A

67701-95J00-000

Applicable Model DF25/R/Q

67701-96J00-000

Applicable Model DF150-175

67701-94420-000

Applicable Model DT25K/30/R



Recommended STEERING SYSTEM supplied by



SEASTAR SOLUTIONS®

www.seastarsolutions.com

Order taking, delivery, technical support and warranty for these products are handled by SeaStar Solutions.

Please consult to local SeaStar Solutions distributor or dealer if you need more detail for product information, price, availability and all business terms.

STEERING KIT

BayStar™



SeaStar®



SeaStar P/A™



BAYSTAR

BAYSTAR OUTBOARD SYSTEM - HK4645H

System comprises:	
BayStar Helm 1.4cu" (22.94cc)	HH4314
BayStar Compact Cylinder	HC4645H*
20ft "cut to length" tubing kit	HT4420H
2 x 1 litre hydraulic oil	HO5430

*Note: 115-140hp four stroke 2001 to current model require HC4658H

SEASTAR

SEASTAR OUTBOARD SYSTEM - HK6400

System comprises:	
SeaStar Helm 1.7cu" (27.80cc)	HH5271
SeaStar Pivot Cylinder	HC5345*
2 x 1 litre hydraulic oil	HO5430

Note: 1 x SeaStar hose kits must be ordered separately
*Note: 115-140hp 1996 only requires HC5348, 40-140hp four stroke 1998 to current model and 90hp four stroke 2003 to current model require HC5358.

SEASTAR POWER ASSIST

SEASTAR OUTBOARD POWER ASSIST SYSTEM

System comprises:	
SeaStar Helm 1.7cu" (27.80cc)	HH5271
SeaStar Pivot Cylinder	HC5345*
2 x 1 litre hydraulic oil	HO5430
SeaStar 12v Power Assist Unit	PA1200-2

Note: 2 x SeaStar hose kits must be ordered separately
*Note: 115-140hp 1996 only requires HC5348, 40-140hp four stroke 1998 to current model and 90hp four stroke 2003 to current model require HC5358.

*For further application information please refer to www.teleflexmarine.com

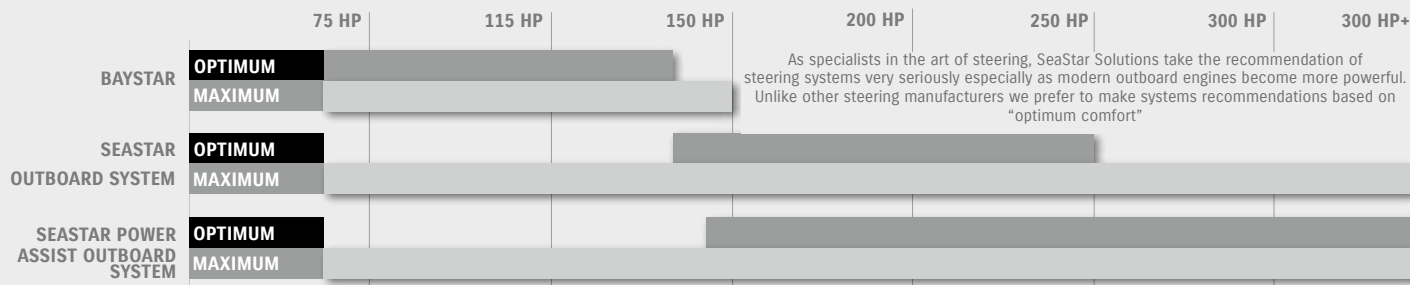

TIE-BAR KIT

Features

General purpose system.
Single and multiple engine capability.
Total power up to 700 HP
*counter-rotating.

Independent engine tilt for twin engine
Easy steering.
5 turns lock to lock steering response.

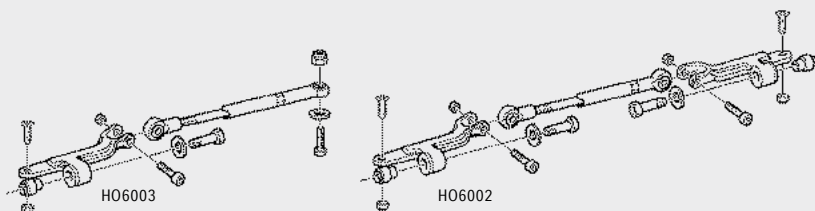

Applications

Twin Engine Application for Suzuki Outboard Motors

MODEL (4-CYCLE)	CYLINDER	TIE BAR KITS		NOTES
		TWIN ENGINE SINGLE CYL.	TWIN ENGINE DUAL CYL.	
DF40A/50A/60A	HC5358	H06003	H06002	Requires kit H05090
DF70A/80A/90A	HC5358	H06003	H06002	Requires kit H05090
DF100	HC5358	H06003	H06002	Requires kit H05090
DF115/140	HC5358	H06003	H06002	Requires kit H05090
DF150/175	HC5345	H06003	H06002	
DF200/225/250	HC5345	H06003	H06002	
DF300	HC5345	H06003	H06002	

Triple Engine Configuration for Suzuki Outboard Motors

MODEL (4-CYCLE)	CYLINDER	TIE BAR KITS		NOTES
		PORT ENGINE TO DRIVE CYL.	STARBOARD ENGINE TO DRIVE CYL.	
DF150/175	HC5345	H06003	H06002	See notice
DF200/225/250	HC5345	H06003	H06002	See notice
DF300	HC5345	H06003	H06002	See notice

Notice : Two cylinders are required to operate a triple engine set up.

ELECTRICAL PARTS

ELECTRIC STARTER KIT



31000-95J10-000 113

Applicable Model DF25

31000-99J00-000

Applicable Model DF8A/9.9A

31000-89L02-000

Applicable Model DF9.9B/15A/20A

Converts MZ model into ME model.

BATTERY CHARGING KIT

32000-91J12-000

80W

Applicable Model DF4-6

32000-95J01-000

80W

Applicable Model DF25/Q

32000-99J00-000

80W

Applicable Model DF8A/9.9A

32000-89L00-000

80W

Applicable Model DF9.9B/15A/20A

COUNTER SELECT CONNECTOR



36612-98J00-000

Applicable Model DF300AP /250AP

Converts DF300AP/250AP to counter rotation specification.

RECTIFIER SET



32801-91J01-000 114

Applicable Model DF4-6



32801-95J01-000 115

Applicable Model DF8A/9.9A/25

32801-89L00-000

Applicable Model DF9.9B/15A/20A



32801-96304-000 116

Applicable Model DT25K/30



32801-94402-000 117

Applicable Model DT40W/40WR/40WK

RECEPTACLE KIT



39600-91J12-000

Applicable Model DF4-6

39600-94J01-000 118

Applicable Model DF8A/9.9A

39600-89L00-000

Applicable Model DF9.9B/15A/20A



39600-95J01-000 119

Applicable Model DF25



39600-93910-000 120

Applicable Model DT9.9AK-40W/WR/WK

STARTER MOTOR SET



31101-96320-0EP 121

Applicable Model DT30

BATTERY ISOLATOR LEAD SET



33830-96J00-000 122

Applicable Model DF150-175

33830-98J10-000

Applicable Model DF300AP/250AP

STATOR & PULSER COIL COMPONENT



32120-95J00-000 123

12V, 180W

Applicable Model DF25/Q

Raises the standard output (12V, 80W) to a larger output (12V, 120 or 180W).

FLYWHEEL



32102-96462-000 124

Applicable Model DT30

STARTING SWITCH & CABLE SET



33800-96304-000 125

Applicable Model DT30

ANODE

ZINC ANODE for saltwater



55300-95500-000 126

Applicable Model DF8A/9.9A/
40A-60A,DT25K-40W



55320-95311-000 127

Applicable Model DF40A-60A/150-300AP



55125-96310-000 128

Applicable Model DF25/R/Q



55321-90J01-000 129

Applicable Model DF40A-60A/100A-140A



55125-95500-000 130

Applicable Model DF100T-140T

ALUMINUM ANODE for brackish water, saltwater



55321-87J00-000 131

Applicable Model DF2.5-300AP,
DT9.9AK/15AK



55320-94900-000 132

Applicable Model DF60A-300AP



55321-95J00-000 133

Applicable Model DF2.5/25/R/Q

55321-93J00-000 134

Applicable Model DF150-300AP

55321-99E00-000 135

Applicable Model DF70AT/TH-300



MAGNESIUM ANODE for freshwater



55321-87J10-000 136

Applicable Model DF4-300AP,DT9.9AK/15AK



55321-94910-000 137

Applicable Model DF70A-300AP

FUEL SYSTEM

FUEL TANK

NOTE : These tanks do not meet US-EPA requirements.



65000-99100-000 138

12-litre plastic tank with no fuel-level gauge

Applicable Model DF4/5/6, DT9.9AK/15AK/25K/40WK (-K:For Gasoline)

65000-95D01-000 139

25-litre plastic tank with a fuel-level gauge

Applicable Model DF8A-140A, DT9.9AK-40W/WR/WK (-K:For kerosene)

65000-89L10-000

12-litre plastic tank with a fuel-level gauge

Applicable Model DF8A-20A

REPLACEMENT FUEL CAP

NOTE : These caps do not meet US-EPA requirements.

65520-99100-000

for 12-litre tank with no fuel-level gauge

Applicable Model DF5-20A/R, DT9.9AK/15AK/25K/40WK

65520-95D00-000

for 25-litre tank with a fuel-level gauge

Applicable Model DF8A-140A, DT9.9K-40W/WR/WK

FUEL-HOSE SOCKET



65750-98505-000 140

Metal, Inner diameter: 11.2 mm

Applicable Model DF4-20A/R, DT9.9K-40W/WR/WK



65750-87J11-000 141

Plastic, Inner diameter: 6.6 mm

Applicable Model DF4/8A-25/R/Q



65750-95500-000 142

Metal, Inner diameter: 13.0 mm

Applicable Model DF8A/R-140A, DT9.9AK-40W/WR/WK

FUEL CONNECTOR (ENGINE SIDE)



65720-986L0-000 143

Plastic

Applicable Model DF4/25/R/Q

FUEL CONNECTOR (TANK SIDE)



65740-95D01-000 144

Outer diameter: 13 mm, 1/4" NPT

Applicable Model DF8A/R-140A, DT9.9K-40W/WR/WK

SQUEEZE PUMP



65770-99J01-000 145

Small-in & Large-out

Applicable Model DF4-6, DT9.9AK/15AK/25K/40WK

65770-90J11-000

Large-in & Large-out

Applicable Model DF9.9B-140A, DT9.9AK/15AK/25K/40WK

65770-93J11-000

Large-in & Large-out

Applicable Model DF150-300AP

65770-94J11-000

Large-in & Small-out

Applicable Model DT9.9A/K-40W/WR/WK

SQUEEZE PUMP (Meets US-EPA requirements.)

65770-94J02-000

Small-in & Large-out

Applicable Model DF4/6

65770-90J01-000

Large-in & Large-out

Applicable Model DF8A-25

65770-93J02-000

Large-in & Large-out

Applicable Model DF150-300AP





FUEL-HOSE COMPONENT

65700-94JD1-000

for 12-litre plastic tank to engine

Applicable Model DF4-9.9A

65700-93J02-000

146

for fuel tank to engine

Applicable Model DF150-300AP

65700-87J15-000

for 25-litre plastic tank to engine

Applicable Model DF9.9B-25

65700-90J14-000

for 25-litre plastic tank to engine

Applicable Model DF40A-140A

65700-95D03-000

for 12-litre plastic tank to engine (gasoline)

Applicable Model DT9.9AK/25K/40WK

65700-96362-000

for 25-litre plastic tank to engine (kerosene)

Applicable Model DT9.9AK/15AK/25K/40WK

65700-94415-000

with fuel filter (gasoline)

Applicable Model DT9.9AK/15AK/25K/40WK

65700-94433-000

with fuel filter (kerosene)

Applicable Model DT9.9AK/15AK

FUEL-HOSE COMPONENT (Meets US-EPA requirements.)

65700-91J24-000

Applicable Model DF4/6

65700-87J24-000

Applicable Model DF8A-25

65700-88L02-000

Applicable Model DF40A-60A

FUEL-HOSE COMPONENT Chart

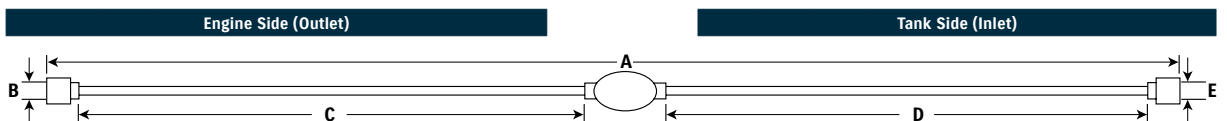

FUEL HOSE COMPONENT		SOCKET			HOSE				SQUEEZE PUMP	HOSE			SOCKET			
Part Number	A Length (mm)	Material	B I/D (mm)	Part Number	C Length (mm)		I/D (mm)	O/D (mm)		D Length (mm)		I/D (mm)	O/D (mm)	Material	E I/D (mm)	Part Number
65700-94JD1-000	1970	Plastic	6.6	65750-87J11-000	700	Large	7.3	12.5	65770-99J01-000	1100	Small	5.3	10.5	Metal	11.2	65750-98505-000
65700-93J02-000	2370	(no socket)	-	-	(no hose)	-	-	-	65770-93J11-000	2250	Large	9.0	14.0	(no socket)	-	-
65700-87J15-000	1970	Plastic	6.6	65750-87J11-000	700		7.3	12.5	65770-90J11-000	1100		7.3	12.5	Metal	13	65750-95500-000
65700-90J14-000	1250	(no socket)	-	-	(no hose)	-	-	-	65770-90J11-000	1100		7.3	12.5	Metal	13	65750-95500-000
65700-95D03-000	2550	Metal	13.0	65750-95500-000	300		7.3	12.5	65770-99J01-000	2090		5.3	10.5	Metal	11.2	65750-98505-000
65700-96362-000	2620	Metal	11.2	65750-98505-000	300		5.3	10.5	-	2250		7.3	12.5	Metal	13	65750-95500-000
65700-94415-000	3100	Metal	13.0	65750-95500-000	300		7.3	12.5	65770-90J11-000	2600		7.3	12.5	-	-	-
65700-94433-000	3100	Plastic	13.8	65750-94404-000	3000		7.3	12.5	-	-		-	-	-	-	-

65700-91J23-000	2000	Plastic	6.6	65750-87J11-000	700		7.3	12.5	65770-94J02-000	1100		5.3	10.5	Metal	11.2	65750-98505-000
65700-87J24-000	2000	Plastic	6.6	65750-87J11-000	700		7.3	12.5	65770-90J01-000	1100		7.3	12.5	Metal	13	65750-95500-000
65700-88L02-000	1280	(no socket)	-	-	(no hose)	-	-	-	65770-90J01-000	1100		7.3	12.5	Metal	13	65750-95500-000

WATER SEPARATOR / FUEL FILTER



99105-20006-ASY 147

Compact size

Applicable Model DF70AT-140T/Z

REPLACEMENT FILTER

99105-20006-000

For compact size

Applicable Model DF70AT-140T/Z

BOWL & DRAIN VALVE ASSEMBLY

99105-20006-BWL

For compact size

Applicable Model DF70AT-140T/Z



65900-98J00-000 148

Including filter element
65910-98J00-000

Applicable Model DF8A-300AP, DT9.9A-40W/
WR/WK

ELEMENT SET



65910-98J00-000 149

For water separator/fuel filter
65900-98J00-000

Applicable Model DF8A-300, DT9.9/K-40W/
WR/WK



PROPELLER



HARDWARE FOR PROPELLER

Applicable Model	
DF2.5	
DF4/5/6	
DF8A/9.9A	
DF9.9B/15A/20A, DT9.9A/15A	
DF25	
DT25/30	
DT40	
DF40A/50A/60A	
DF50AV/60AV	
DF70A/80A/90A	
DF100A/115A	T model (Right-Hand-Rotation)
DF115A	Z model (Counter-Rotation)
DF140A	
DF150-300AP	

*RR:Right-Hand-Rotation model, CR: Counter-Rotation model

model	type	material	blade	diameter	pitch	rotation*	description	part number
DF2.5	A520	Aluminum	3	7 3/8	5 3/8	RR		58110-97JA0-019
DF4	C601	Aluminum	3	7 1/2	6	RR		58110-91JL0-019
DF5	C611	Aluminum	3	7 1/2	6 1/2	RR		58110-91JM0-019
DF6	C701	Aluminum	3	7 1/2	7	RR		58110-91JN0-019
DF8A	M701	Aluminum	3	9 1/4	7	RR		58100-93703-019
DF9.9A	M821	Aluminum	3	9 1/4	8	RR	THICK	58100-90L01-019
	M901	Aluminum	3	9 1/4	9	RR		58100-94J00-019
	M911	Aluminum	3	9 1/4	9	RR	THICK	58100-90L11-019
	M1001	Aluminum	3	9 1/4	10	RR		58100-93733-019
	M1011	Aluminum	3	9 1/4	10	RR	THICK	58100-90L21-019
	M1101	Aluminum	3	9 1/4	11	RR		58100-93743-019
DF9.9B		Aluminum	4	10	5	RR	High thrust	58100-94JA0-019
DF9.9B								
DF15A		Aluminum	3	9 1/4	7	RR		58100-89L00-019
DF20A		Aluminum	3	9 1/4	8	RR	THICK	58100-90L40-019
		Aluminum	3	9 1/4	9	RR		58100-89L20-019
DT9.9A		Aluminum	3	9 1/4	9	RR	THICK	58100-90L50-019
DT15A		Aluminum	3	9 1/4	10	RR		58100-89L30-019
		Aluminum	3	9 1/4	10	RR	THICK	58100-90L60-019
		Aluminum	3	9 1/4	11	RR		58100-89L40-019
		Aluminum	3	9 1/4	12	RR		58100-89L50-019
DF25	P911	Aluminum	3	10 1/4	9	RR	THICK	58100-96371-019
DT25	P1001	Aluminum	3	10 1/4	10	RR		58100-96411-019
DT30	P1011	Aluminum	3	10 1/4	10	RR	THICK	58100-96471-019
	P1101	Aluminum	3	10 1/4	11	RR		58100-96421-019
	P1201	Aluminum	3	10 1/4	12	RR		58100-91L00-019
	P1211	Aluminum	3	10 1/4	12	RR	THICK	58100-96481-019
	P1301	Aluminum	3	10 1/4	13	RR		58100-91L10-019
	P1311	Aluminum	3	10 1/4	13	RR	THICK	58100-96491-019
	P1401	Aluminum	3	10 1/4	14	RR		58100-95D01-019
	P1501	Aluminum	3	10 1/4	15	RR		58100-96461-019
DT25/30	PS1300	Stainless	3	10 1/4	13	RR		58200-96400-000
DF40A	S900	Aluminum	3	11 1/2	9	RR		58100-88L03-019
DF50A	S1000	Aluminum	3	11 1/2	10	RR		58100-88L13-019
DF60A	S1100	Aluminum	3	11 1/2	11	RR		58100-88L23-019
DT40	S1200	Aluminum	3	11 5/8	12	RR		58100-88L32-019
	S1301	Aluminum	3	11 1/2	13	RR		58100-88LB0-019
	S1400	Aluminum	3	11 3/8	14	RR		58100-88L52-019
	S1500	Aluminum	3	11 1/4	15	RR		58100-88L62-019
	S1600	Aluminum	3	11 1/8	16	RR		58100-88L72-019
	S1700	Aluminum	3	11	17	RR		58100-88L83-019
	SS1600	Stainless	3	11 1/8	16	RR		58200-88L30-000
DF50AV		Aluminum	3	14	9	RR		58100-87LG1-019
DF60AV		Aluminum	3	14	11	RR		58100-87LH0-019
		Aluminum	3	13 3/4	12	RR		58100-87LJ0-019
		Aluminum	3	14	13	RR		58100-87LA0-019
		Aluminum	3	13 7/8	15	RR		58100-87LB0-019
		Aluminum	3	13 3/4	17	RR		58100-87LC0-019



	STOPPER		PROPELLER BUSH		HARDWARE KIT				
	SPACER				Contents of HARDWARE KIT				
					SPACER	WASHER	NUT	COTTER PIN	
57635-91JL0-000	-		58120-97JA0-000	Press-In	N/A	-	-	58130-91JL0-000	09204-03003-000
57635-91JL0-000	-		58120-91JL0-000	Press-In	N/A	-	-	58130-91JL0-000	09204-03003-000
57632-94J00-000	-		58120-93701-000	Press-In	N/A	-	09160-12066-000	09141-12005-000	09204-02004-000
57632-94J00-000	-		58120-89L00-000	Press-In	N/A	-	09160-12066-000	09141-12005-000	09204-02004-000
57632-95J00-000	-		58120-96401-000	Press-In	57630-96300-000	57633-96300-000	09160-14028-000	09141-14008-000	09204-03003-000
57632-91L00-000	-		58120-96401-000	Press-In	57630-96300-000	57633-96300-000	09160-14028-000	09141-14008-000	09204-03003-000
57632-92L00-000	-		58120-88L01-000	Press-In	57630-94300-000	57633-94300-000	09160-18028-000	09141-18005-000	09204-03003-000
57632-95320-000	-		58120-88L01-000	Press-In	57630-94300-000	57633-94300-000	09160-18028-000	09141-18005-000	09204-03003-000
57635-90J01-000	-		*58105-90J00-000	Press-In	57630-94500-000	57633-90J02-000	09160-18028-000	09141-18005-000	09204-03003-000
57632-87L00-000	-				57630-90J00-000	57633-90J02-000	09160-18028-000	09141-18005-000	09204-03003-000
57635-92J01-000	57632-90J00-000		*58105-90J00-000	Press-In	57630-90J00-000	57633-90J02-000	09160-18028-000	09141-18005-000	09204-03003-000
57635-92J01-000	-		**58120-90J00-000		57630-90J00-000	57633-90J02-000	09160-18028-000	09141-18005-000	09204-03003-000
57635-92J01-000	-				57630-90J00-000	57633-90J02-000	09160-18028-000	09141-18005-000	09204-03003-000
57632-93L00-000	-		***58105-93J00-000	Press-In	57630-92E00-000	57633-87D30-000	09160-18028-000	09141-18005-000	09204-03003-000
			****58105-93J10-000						

*58105-90J00 is for 58100-87Lxx, 58100-90Jxx, 58200-92J4x-92J9x and 58200-92JAx-92JDx.
**58120-90J00 is for 58200-90J0x-90J3x and 58200-92J0x-92J3x.
***58105-93J00 is for 58200-96Jxx.
****58105-93J10 is for 58200-93JXX, 58200-93Lxx and 58300-93Jxx.

model	material	blade	diameter	pitch	rotation*	part number
DF70A	Aluminum	3	14	13	RR	58100-87LA0-019
DF80A	Aluminum	3	13 7/8	15	RR	58100-87LB0-019
DF90A	Aluminum	3	13 3/4	17	RR	58100-87LC0-019
	Aluminum	3	13 3/4	19	RR	58100-87LD0-019
	Aluminum	3	13 3/4	21	RR	58100-87LE0-019
	Aluminum	3	13 3/4	23	RR	58100-87L50-019
	Aluminum	3	13 1/2	15	RR	58100-90JE0-019
	Aluminum	3	14	17	RR	58100-90JA0-019
	Aluminum	3	14	19	RR	58100-90JB0-019
	Aluminum	3	14	21	RR	58100-90JC0-019
	Aluminum	3	14	23	RR	58100-90JD0-019
	Stainless	3	14 1/4	18	RR	99105-00700-18P
	Stainless	3	14 1/4	20	RR	99105-00700-20P
	Stainless	3	14 1/4	22	RR	99105-00700-22P
	Stainless	3	14 1/4	24	RR	99105-00700-24P
	Stainless	3	13 7/8	15	RR	58200-92J40-000
	Stainless	3	13 7/8	17	RR	58200-92J50-000
	Stainless	3	13 7/8	19	RR	58200-92J60-000
	Stainless	3	13 7/8	21	RR	58200-92J70-000
	Stainless	3	13 7/8	23	RR	58200-92J80-000
Stainless	3	13 7/8	25	RR	58200-92J90-000	
DF100A	Aluminum	3	13 1/2	15	RR	58100-90JE0-019
DF115A	Aluminum	3	14	17	RR	58100-90JA0-019
DF140A	Aluminum	3	14	19	RR	58100-90JB0-019
	Aluminum	3	14	21	RR	58100-90JC0-019
	Aluminum	3	14	23	RR	58100-90JD0-019
	Stainless	3	14 1/4	18	RR	99105-00700-18P
	Stainless	3	14 1/4	20	RR	99105-00700-20P
	Stainless	3	14 1/4	22	RR	99105-00700-22P
	Stainless	3	14 1/4	24	RR	99105-00700-24P
	Stainless	3	14 1/4	18	CR	99105-0070L-18P
	Stainless	3	14 1/4	20	CR	99105-0070L-20P
	Stainless	3	14 1/4	22	CR	99105-0070L-22P
	Stainless	3	14 1/4	24	CR	99105-0070L-24P
	Stainless	3	13 7/8	15	RR	58200-92J40-000
	Stainless	3	13 7/8	17	RR	58200-92J50-000
	Stainless	3	13 7/8	19	RR	58200-92J60-000
	Stainless	3	13 7/8	21	RR	58200-92J70-000
	Stainless	3	13 7/8	23	RR	58200-92J80-000
	Stainless	3	13 7/8	25	RR	58200-92J90-000
	Stainless	3	13 7/8	17	CR	58200-92JA0-000
	Stainless	3	13 7/8	19	CR	58200-92JB0-000
	Stainless	3	13 7/8	21	CR	58200-92JC0-000
	Stainless	3	13 7/8	23	CR	58200-92JD0-000

model	material	blade	diameter	pitch	rotation*	part number
DF150	Stainless	3	16	15	RR	58200-93L80-000
DF175	Stainless	3	16	17	RR	58200-93L00-000
DF200	Stainless	3	16	18 1/2	RR	58200-93L10-000
DF225	Stainless	3	16	20	RR	58200-93L20-000
DF250	Stainless	3	16	21 1/2	RR	58200-93L30-000
DF250AP	Stainless	3	16	23	RR	58200-93L40-000
DF300AP	Stainless	3	16	24 1/2	RR	58200-93L50-000
	Stainless	3	16	26	RR	58200-93J60-000
	Stainless	3	16	27 1/2	RR	58200-93J70-000
	Stainless	3	16	17	CR	58200-93LE0-000
	Stainless	3	16	18 1/2	CR	58200-93LA0-000
	Stainless	3	16	20	CR	58200-93LB0-000
	Stainless	3	16	21 1/2	CR	58200-93LC0-000
	Stainless	3	16	23	CR	58200-93LD0-000
	Stainless	3	16	24 1/2	CR	58200-93LF0-000
	Stainless	3	16	26	CR	58200-93JG0-000
	Stainless	3	15 1/2	17	RR	58200-96J00-000
	Stainless	3	15 1/4	19	RR	58200-96J10-000
	Stainless	3	15	21	RR	58200-96J20-000
	Stainless	3	14 3/4	23	RR	58200-96J30-000
	Stainless	3	14 1/2	25	RR	58200-96J40-000
	Stainless	3	14 1/2	27	RR	58200-96J50-000
	Stainless	3	15 1/2	17	CR	58200-96JA0-000
	Stainless	3	15 1/4	19	CR	58200-96JB0-000
	Stainless	3	15	21	CR	58200-96JC0-000
	Stainless	3	14 3/4	23	CR	58200-96JD0-000
	Stainless	3	14 1/2	25	CR	58200-96JE0-000
	Stainless	3	14 1/2	27	CR	58200-96JF0-000
	Stainless	4	15 1/4	18	RR	58300-93J00-000
	Stainless	4	15 1/4	20	RR	58300-93J10-000
	Stainless	4	15 1/4	22	RR	58300-93J20-000
	Stainless	4	15 1/4	24	RR	58300-93J30-000
	Stainless	4	15 1/4	26	RR	58300-93J40-000
	Stainless	4	15 1/4	20	CR	58300-93JA0-000
	Stainless	4	15 1/4	22	CR	58300-93JB0-000
	Stainless	4	15 1/4	24	CR	58300-93JC0-000
	Stainless	4	15 1/4	26	CR	58300-93JD0-000

CARE ITEM

ENGINE COVER



68110-89L00-000 150

Applicable Model DF8A-20A, DT9.9A-15A

68110-88L00-000 151

Applicable Model DF25/40A-60A, DT25/30

68110-87L00-000 152

Applicable Model DF70A-140A, DT40

68110-96J00-000 153

Applicable Model DF150T/Z-250T/Z

68110-98J00-000 154

Applicable Model DF250AP/300AP

FLUSH-HOSE ATTACHMENT



55181-95200-000 155

Applicable Model DF4-6/40A-60A,
DT25K/30/40W



17917-87L00-000 156

Applicable Model DF8A-300A

ENGINE COVER



990F0-88L00-010 157

Applicable Model DF40A/DF50A/DF60A with
new 4stroke logo



990F0-87J00-010

Applicable Model DF40/50

990F0-99E00-010 158

Applicable Model DF60/70

990F0-87L00-010

Applicable Model DF70A/80A/90A

990F0-90J00-010

Applicable Model DF90/115

990F0-92J00-010

Applicable Model DF140

990F0-96J00-010

Applicable Model DF150/175

990F0-93J00-010

Applicable Model DF200/225/250

990F0-98J00-010

Applicable Model DF300

PROPELLER COVER



990F0-87J00-020 159

11-12"/30cm

990F0-87L00-020

13-14"/35cm

990F0-93J00-020

15-16"/40cm

CARRY ON BAG



990F0-97J00-B25 160

Applicable Model DF2.5

Robust nylon textile bag, tailor made for
transport and storage of the engine.

MAINTENANCE ITEM

GREASE



99000-25011-000 161
 SUPER GREASE-A
 450 grams (15.8 oz) for crank oil seal



99000-25350-000 162
 WATER RESISTANT GREASE EP2
 250 grams (8.8 oz)



99000-25140-000 163
 MOLY PASTE
 50 grams (1.7 oz)

LIQUID GASKET



99000-31140-THR 164
 1207B (BLACK)
 100 grams (3.4 oz)

THREAD LOCK



99000-32130-000 165
 1360 (RED)
 50 grams (1.7 oz)



99000-32110-THR 166
 1342 (BLUE)
 50 grams (1.7 oz)

PAINT

99000-10202-0EP

Touch-up paint set black
 12ml

997SO-41004-CLR

167

AE clear coat
 400ml

997SO-41004-0EP

168

AE shadow black metallic
 400ml

997SO-41004-0ED

169

AE california grey metallic
 400ml



MAINTENANCE ITEM

SUZUKI APPROVED GENUINE OIL BY MOTUL

Suzuki and MOTUL have been in partnership in MotoGP since 1988. Extending this trusted relationship led to the development of new Suzuki marine oils. These ranges of oils have excellent oxidation stability and provide outstanding rust protection under extreme operating conditions.

API Classification	SAE Viscosity Grade												
SG												10W-40	
SH												10W-40	
SL												10W-40	
SJ												10W-40	
SM												10W-40	
TEMP.	C	-20	-10	0	10	20	30	40					
	F	-4	14	32	50	68	86	104					

GEAR OIL



99000-79N12-M07 170

SAE 90, API GL-5

Packaging unit 24 x 0.35 litre



99000-79N12-M08 171

"S" MARINE GEAR OIL SAE90

Packaging unit 12 x 1 litre

4STROKE ENGINE OIL



99000-79N12-M01 172

SAE 10W-30 semi synthetic

4 x 5 litre FCW

99000-79N12-M00

SAE 10W-30 semi synthetic

20 x 1 litre FCW

99000-79N12-M02

SAE 10W-30 semi synthetic

60 litre FCW

99000-79N12-M09

SAE 10W-30 semi synthetic

208 litre FCW



99000-79N12-M04 173

SAE 10W-40 semi synthetic

4 x 5 litre FCW

990F0-79N12-M03

SAE 10W-40 semi synthetic

12 x 1 litre FCW

99000-79N12-M05

SAE 10W-40 semi synthetic

60 litre FCW

99000-79N12-M10

SAE 10W-40 semi synthetic

208 litre FCW

Part name	Volume	Part number	DF300	DF250	DF225	DF200	DF175	DF150	DF140	DF115	DF100	DF90A	DF80A	DF70A	DF60
LIQUID GASKET	1207B (BLACK)	100 grams (3.4 oz)	99000-31140-THR 165	0	0	0	0	0	0	0	0	0	0	0	0
GREASE	SUPER GREASE-A	450 grams (15.8 oz)	99000-25011-000 162	0	0	0	0	0	0	0	0	0	0	0	0
GREASE	WATER RESISTANT GREASE EP2	250 grams (8.8 oz)	99000-25350-000 163	0	0	0	0	0	0	0	0	0	0	0	0
GREASE	MOLY PASTE	50 grams (1.7 oz)	99000-25140-000 164	0	0	0	0	0	0	0	0	0	0	0	0
THREAD LOCK	1360 (RED)	50 grams (1.7 oz)	99000-32130-000 166	0	0	0	0	0	0	0	0	0	0	0	0
THREAD LOCK	1342 (BLUE)	50 grams (1.7 oz)	99000-32110-THR 167	0	0	0	0	0	0	0	0	0	0	0	0
GEAR OIL	HYPOID GEAR OIL SAE90 APIGL-5	350ml	99000-79N12-M07 171	0	0	0	0	0	0	0	0	0	0	0	0

O: Available - : Not available

HYDRAULIC FLUID



990F0-22541-001 174

Dexron III for all Suzuki 2 and 4 stroke outboard powertrim/tilt systems
1 litre

INHIBITOR



997S0-KONS3-001 175

P4
250 ml

	DF50	DF40	DF25	DF15	DF9.9	DF6	DF5	DF4	DF2.5
	0	0	0	0	0	0	0	0	0
	0	0	0	0	0	0	0	0	-
	0	0	0	0	0	0	0	0	0
	0	0	0	0	0	0	0	0	0
	-	-	0	0	0	-	-	-	-
	0	0	0	0	0	0	0	0	0
	0	0	0	0	0	0	0	0	0

BATTERIES

STARTER BATTERY



990F0-OPSTA-055 176

Optima BlueTop DC4.2
Nominal voltage 12 volts, capacity 55 Ah

990F0-OPSTA-075

Optima BlueTop DC5.5
Nominal voltage 12 volts, capacity 75 Ah

STARTER BATTERY/ SUB BATTERY

990F0-OPVER-050

Optima BlueTop SLI4.2
Nominal voltage 12 volts, capacity 50 Ah

BATTERY CHARGER



990E0-OPTIM-CAR 177

OptiMate 6, versatile battery charger, maintainer and tester. Recommended for STS/AGM/MF/GEL and spiral cell batteries from 15 Ah to 240 Ah.

ALARM SYSTEMS

ALARM SYSTEM, COMPACT VERSION



990F0-ALARM-002 178

Applicable Models DF40-DF140 from 2005-
FD250 from 2004-2012
DF200 from 2004-
DF150-DF175 from 2006-

Easy to mount, Suzuki outboard engine dedicated plug & play connection. The various features of this waterproof remote controlled alarm system include e.g. system disarming by pin code, remote control, optical and acoustical signalization, engine stop function, cable cutting protection, and many more. Includes 1 micro magnetic contact.

MICRO MAGNETIC CONTACT FOR ALARM SYSTEM

990F0-ALARM-004

Additional waterproof micro magnetic contact for alarm system 990F0-ALARM-002. To be used e.g. for dashboard driving console and access point protection (sliding doors, windows).



APPLICATION CHART

page	Part Name / Description	DF250AP/300AP	DF200/225/250	DF150TG(ZG)/175TG(ZG)	DF150/175	DF140A	DF100A/115A
22, 26	REMOTE CONTROL BOX						
	Binnacle-mount for Single-Engine	67200-98J03-000 062	67200-93J13-000 082	67200-98J03-000 062	67200-93J13-000 082	67200-93J13-000 082	67200-93J13-000 082
	for Dual-Engine	67200-98J13-000 064	67200-93J23-000 083	67200-98J13-000 064	67200-93J23-000 083	67200-93J23-000 083	67200-93J23-000 083
	Flush-mount for Single-Engine	67200-98J22-000 063	67200-93J32-000 084	67200-98J22-000 063	67200-93J32-000 084	67200-93J32-000 084	67200-93J32-000 084
	Side-mount for Single-Engine	-	67200-93J06-000	-	67200-93J06-000	67200-93J06-000	67200-93J06-000
22, 26	Binnacle-mount REMOTE CONTROL KIT						
	for Single-Engine + Single-station	without Gauge	67000-98J08-000	67000-93J04-000	67000-98J08-000	67000-93J04-000	67000-93J04-000
		with Gauge	-	67000-93J47-000	-	67000-93J47-000	67000-93J47-000
	+ Second-station	without Gauge	67000-98J18-000	-	67000-98J18-000	-	-
	for Dual-Engine + Single-station	without Gauge	67000-98J28-000	67000-93J14-000	67000-98J28-000	67000-93J14-000	67000-93J14-000
		with Gauge	-	67000-93J57-000	-	67000-93J57-000	67000-93J57-000
	+ Second-station	without Gauge	67000-98J38-000	-	67000-98J38-000	-	-
	for Triple-Engine + Single-station	without Gauge	67000-98J48-000	-	67000-98J48-000	-	-
		with Gauge	-	-	-	-	-
	+ Second-station	without Gauge	67000-98J58-000	-	67000-98J58-000	-	-
	for Quad-Engine + Single-station	without Gauge	67000-98J70-000	-	67000-98J70-000	-	-
		with Gauge	-	-	-	-	-
	+ Second-station	without Gauge	67000-98J80-000	-	67000-98J80-000	-	-
22, 26	Flush-mount REMOTE CONTROL KIT						
	for Single-Engine + Single-station	67000-98J67-000	67000-93J25-000	67000-98J67-000	67000-93J25-000	67000-93J25-000	67000-93J25-000
			67000-93J68-000	-	67000-93J68-000	67000-93J68-000	67000-93J68-000
27	Side-mount REMOTE CONTROL KIT						
	for Single-Engine + Single-station	-	67000-93J78-000	-	67000-93J78-000	67000-93J78-000	67000-93J78-000
26	SPACER KIT for REMOTE CONTROL BOX						
	for Single Binnacle-mount type	-	67500-93J00-000 086	-	67500-93J00-000 086	67500-93J00-000 086	67500-93J00-000 086
	for Dual Binnacle-mount type	-	67500-93J10-000 087	-	67500-93J10-000 087	67500-93J10-000 087	67500-93J10-000 087
29	REMOTE-CONTROL CABLE						
		-	See page 29	-	See page 29	See page 29	See page 29
29	REMOTE-CONTROL ATTACHING KIT						
		-	-	-	-	-	-
25, 27	MAIN WIRING HARNESS						
	5.0 meters	-	36620-93J52-000	-	36620-93J52-000	36620-93J52-000	36620-93J52-000
	6.5 meters	36620-98J30-000 74	36620-93J02-000 088	36620-98J30-000	36620-93J02-000 088	36620-93J02-000 088	36620-93J02-000 088
	8.0 meters	-	36620-93J62-000	-	36620-93J62-000	36620-93J62-000	36620-93J62-000
	9.5 meters	36620-98J40-000	-	36620-98J40-000	-	-	-
25, 27	MAIN-WIRING-HARNESS EXTENSION						
	2.0 meters	36620-98J50-000 075	36620-93J10-000	36620-98J50-000	36620-93J10-000	36620-93J10-000	36620-93J10-000
	3.0 meters	-	36620-93J40-000	-	36620-93J40-000	36620-93J40-000	36620-93J40-000
25, 27	BATTERY LEAD						
		36625-98J10-000 078	36625-93J10-000 089	36625-98J10-000 078	36625-93J10-000 089	-	-
28	IGNITION SWITCH PANEL						
	Single ignition	-	37100-96J00-000 090	-	37100-96J00-000 090	37100-96J00-000 090	37100-96J00-000 090
	Single ignition + Emergency-stop switch	-	37100-96J23-000 093	-	37100-96J23-000 093	37100-96J23-000 093	37100-96J23-000 093
	Dual ignition + Emergency-stop switch	-	37100-96J13-000 094	-	37100-96J13-000 094	37100-96J13-000 094	37100-96J13-000 094
24	MAIN SWITCH PANEL						
		37100-98J03-000 065	-	37100-98J03-000	-	-	-
24	CONTROL PANEL						
	for Single engine	37100-98J11-000 066	-	37100-98J11-000 066	-	-	-
	for Dual engine	37100-98J21-000 067	-	37100-98J21-000	-	-	-
	for Triple engine	37100-98J31-000 068	-	37100-98J31-000	-	-	-
	for Quad engine	37100-98J21-000*2	-	37100-98J21-000*2	-	-	-
28	EMERGENCY SWITCH PANEL						
		37803-93J03-000 091	37803-93J03-000 091	37803-93J03-000	37803-93J03-000 091	37803-93J03-000 091	37803-93J03-000 091
28	PTT SWITCH PANEL						
		-	37805-93J00-000 096	-	37805-93J00-000 096	37805-93J00-000 096	37805-93J00-000 096
28	LIGHTING SWITCH PANEL						
		-	37210-93J00-000 092	-	37210-93J00-000 092	37210-93J00-000 092	37210-93J00-000 092
34	STATOR & PULSER COIL COMPONENT						
		-	-	-	-	-	-
33	ELECTRIC STARTER KIT						
		-	-	-	-	-	-
33	BATTERY CHARGING KIT						
		-	-	-	-	-	-
34	BATTERY ISOLATOR LEAD SET						
		33830-98J10-000	-	33830-96J00-000	33830-96J00-000 122	-	-
34	ANODE						
		See page 34	See page 34	See page 34	See page 34	See page 34	See page 34
30	TILLER HANDLE KIT						
		-	-	-	-	-	63002-90J30-0EP 108
31	STEERING EXTENSION KIT						
		-	67630-93J00-000 111	-	67630-93J00-000 111	-	-
31	DRAG-LINK KIT						
		-	67700-93J00-000	-	67700-96J00-000	67701-90J00-000	67701-90J00-000
31	STEERING-BRACKET ATTACHMENT						
		-	-	-	-	-	-
31	DUAL-ENGINE TIE-BAR						
		-	67600-93J00-000	-	67600-93J00-000	67600-90J00-000 110	67600-90J00-000 110
35	FUEL TANK						
		-	-	-	-	65000-95D01-000 139	65000-95D01-000 139
36	FUEL-HOSE COMPONENT						
		See page 36	See page 36	See page 36	See page 36	See page 36	See page 36
38	PROPELLER						
		See page 38-39	See page 38-39	See page 38-39	See page 38-39	See page 38-39	See page 38-39

DF70A/80A/90A	DF40A/50A/60A	DF25	DF9.9B/15A/20A	DF8A/9.9A	DF4/5/6	DT40	DT25/30	DT9.9/15
67200-93J13-000 082	67200-93J13-000 082	67200-93J13-000 082	67200-93J13-000 082	67200-93J13-000 082	-	-	-	-
-	-	-	-	-	-	-	-	-
67200-93J32-000 084	67200-93J32-000 084	67200-93J32-000 084	-	-	-	-	-	-
67200-93J06-000	67200-93J06-000	67200-94J15-000 085	67200-94J15-000 085	67200-94J15-000 085	67200-91J04-000 085	67200-97E44-000	67200-97E44-000	-
67000-93J04-000	67000-93J04-000	-	-	-	-	-	-	-
67000-93J47-000	67000-93J47-000	-	-	-	-	-	-	-
-	-	-	-	-	-	-	-	-
-	-	-	-	-	-	-	-	-
-	-	-	-	-	-	-	-	-
-	-	-	-	-	-	-	-	-
-	-	-	-	-	-	-	-	-
-	-	-	-	-	-	-	-	-
-	-	-	-	-	-	-	-	-
-	-	-	-	-	-	-	-	-
-	-	-	-	-	-	-	-	-
-	-	-	-	-	-	-	-	-
-	-	-	-	-	-	-	-	-
67000-93J78-000	67000-93J78-000	-	-	-	-	-	-	-
67500-93J00-000 086	67500-93J00-000 086	67500-93J00-000 086	67500-93J00-000 086	67500-93J00-000 086	-	-	-	-
-	-	-	-	-	-	-	-	-
See page 29	See page 29	See page 29	See page 29	See page 29	See page 29	See page 29	See page 29	See page 29
-	-	67130-95J02-000 103	67130-89L01-000	67130-99J00-000	67130-91J02-000 102	-	-	-
36620-93J52-000	36620-93J52-000	-	-	-	-	-	-	-
36620-93J02-000 088	36620-93J02-000 088	36620-94J01-000	36620-94J01-000	36620-94J01-000	-	36620-94J01-000	-	-
36620-93J62-000	36620-93J62-000	-	-	-	-	-	-	-
-	-	-	-	-	-	-	-	-
36620-93J10-000	36620-93J10-000	36620-93J10-000	36620-93J10-000	-	-	-	-	-
36620-93J40-000	36620-93J40-000	36620-93J40-000	36620-93J40-000	-	-	-	-	-
-	-	-	-	-	-	-	-	-
37100-96J00-000 090	37100-96J00-000 090	37100-96J00-000 090	37100-96J00-000 090	-	-	-	37100-99E00-000	-
37100-96J23-000 093	37100-96J23-000 093	37100-96J23-000 093	37100-96J23-000 093	-	-	37100-96J23-000 093	-	-
-	-	-	-	-	-	-	-	-
-	-	-	-	-	-	-	-	-
-	-	-	-	-	-	-	-	-
-	-	-	-	-	-	-	-	-
37803-93J03-000 091	37803-93J03-000 091	37803-93J03-000 091	37803-93J03-000 091	-	-	-	37803-99E03-000	-
37805-93J00-000 096	37805-93J00-000 096	-	-	-	-	-	-	-
37210-93J00-000 092	37210-93J00-000 092	37210-93J00-000 092	37210-93J00-000 092	-	-	37210-93J00-000 092	37210-93J00-000 092	-
-	-	32120-95J00-000 123	-	-	-	-	-	-
-	-	31000-95J10-000 113	31000-89L02-000	31000-99J00-000	-	-	-	-
-	-	32000-95J01-000	32000-89L00-000	32000-99J00-000	32000-91J12-000	-	-	-
-	-	-	-	-	-	-	-	-
See page 34	See page 34	See page 34	See page 34	See page 34	See page 34	See page 34	See page 34	See page 34
63002-87L11-0EP 107	63002-88L10-0EP 106 63002-88L20-0EP 105	-	-	-	-	-	-	-
-	-	-	-	-	-	-	-	-
67701-87L01-000	67701-87J11-000	67700-95J01-000	-	-	-	-	67701-94420-000	-
-	-	43755-95J01-000	-	-	-	-	-	-
-	-	-	-	-	-	-	-	-
65000-95D01-000 139	65000-95D01-000 139	65000-95D01-000 139	65000-89L10-000	65000-89L10-000	65000-99100-000 138	65000-95D01-000 139	65000-95D01-000 139	65000-95D01-000 139
See page 36	See page 36	See page 36	See page 36	See page 36	See page 36	See page 36	See page 36	See page 36
See page 38-39	See page 38-39	See page 38-39	See page 38-39	See page 38-39	See page 38-39	See page 38-39	See page 38-39	See page 38-39

CLOTHING AND MERCHANDISE

WORK



999LP-05401-size 002

WORKCOAT SHORT

Dark blue with white stripes and red piping. Turn down collar, velcro fastenings throughout and multifunctional pockets on chest and sleeves, with Suzuki detailing, 60% Cotton, 40% Polyester.

Size 044-106



999LP-05404-size 003

OVERALL

Dark blue with white stripes and red piping. High collar, knee patches and an adjustable elastic waistband for comfort. velcro fastenings throughout and multifunctional pockets on chest, sleeves and legs, with Suzuki detailing, 60% Cotton, 40% Polyester.

Size 044-106



999LP-05405-size 001

WORKCOAT

Dark blue with white stripes and red piping. High collar, velcro fastenings throughout and multifunctional pockets on chest and sleeves, with Suzuki detailing, 60% Cotton, 40% Polyester.

Size 044-062



999LP-05400-size 004

PIT DUNGAREES

Blue with red piping. Velcro fastenings throughout with multifunctional pockets. Stretch straps, knee patches, fly with zip fastener, adjustable elasticated waistband and woven Suzuki logo, 60% Cotton, 40% Polyester.

Size 044-106



990F0-GLOVE-size 005

WORKING GLOVES

Blue/anthracite with Suzuki logo, grip for dry and wet environment, breathable material, aqua polymer foam coating for more protection against moisture, derma-tologically approved, 90% Polyamide, 10% Elastane.

Size 008/009/010



999LP-05402-size 006

WORKSHOP TROUSERS

Dark blue with an elasticated back, knee patches, velcro fastenings throughout, multifunctional pockets on legs and woven Suzuki logo, 60% Cotton, 40% Polyester.

Size 044-106



990F0-BLA12-size 007

WORKSHOP T-SHIRT

Black, short sleeves and Suzuki logo, 65% Polyester, 35% Cotton.

Size S/M/L/XL/XXL



990F0-05407-size 008

WORKSHOP POLO SHIRT

Dark blue with red contrasting coloured stripes, polo collar, cuffed sleeves and Suzuki logo, 100% Cotton.

Size S/M/L/XL/XXL

* While stocks last

H = Height, W = Width, D = Depth, C = Capacity

MERCHANDISE



990F0-MBACK-000 009

BACKPACK

Day pack, functional addition to touring luggage, multiple functional pockets, bottle holder, waist and chest belts, eyelet fitted pocket for mp3 player and phone, 600D Polyester.

Size H48cm/W25cm/D15cm/C24 litres



990F0-MLAN1-000 012

LANYARD

Black fabric strap detailed with Suzuki logo and metal key ring.



990F0-MWAL1-000 015

WALLET

Black lightweight wallet with embroidered Suzuki logo on front. Cordura fabric with nylon lining. Hook for key fixation and coin zipper pocket inside.

Size H15cm/W11.5cm/D2cm



990F0-DRYHB-001 010

SUZUKI DRY HIPBAG

Waterproof hip bag made of welded tarpaulin, reflective details, adjustable waist belt.

Size C2.5 litres



990F0-MMUG1-000 013

SUZUKI MUG

Black design with Suzuki logo, ceramic, suitable for microwave and dishwasher.



990F0-MUMB1-000 016

UMBRELLA

Black with white Suzuki logo detail, windproof with ergonomic EVA soft handle, comes in bag with shoulder strap, nylon with fiberglass spokes and metal shaft.

Size Diameter 130cm



990F0-MWAT2-000 011

WATCH

Black stainless steel case. Date and time function, silicon strap, dial with carbon inset, mineral crystal dial glass, diameter 44mm, 5ATM water resistant.



990F0-MSUN1-000 014

SUNGLASSES

Stylish and lightweight, with 100% UV A and B protection made from acrylic with embossed Suzuki logo. Comes with EVA case and microfiber pouch.



990F0-MKEY1-000 017

SUZUKI KEY RING

Black/white, PVC.

GET YOUR "SUZUKI COLLECTION" CATALOGUE NOW!

You want the perfect outfit for yourself and unique Suzuki merchandise? More you can find in the current Suzuki collection catalogue you can get from your Suzuki partner. Suzuki International Europe GMBH reserves the right to change, without notice, specifications, colours, materials and other items of clothing and merchandise products. Individual accessory items may be discontinued without notice. Product may vary from image shown. Please check with your local Suzuki Dealer for any such changes. Please confirm the full specification of your chosen accessory prior to purchase and fitment. Actual colours may differ slightly from the colours in this brochure. All details are correct at time of going to press.

Suzuki accessories are designed specifically for Suzuki vehicles and are subject to the same quality standards as the vehicles themselves. We would like to draw your specific attention to the fact that only Suzuki original accessories are tested and approved by Suzuki. The requirements they have to meet are set out in the relevant manuals. Under certain circumstances, the installation and/or usage of other accessory parts may therefore have a negative impact on the characteristics of your vehicle as set out in the design specifications, thereby impairing ride safety. Suzuki cannot, under any circumstances, be made liable for damage occurring from the use of any accessory that is not a Suzuki original accessory.

Subject to engineering and design modifications without prior notice. Please consult the current price list for details of accessory prices.

The details given in this brochure are non-binding and are purely for informational purposes. Errors excepted.

Suzuki International Europe GmbH,
Suzuki Allee 7, 64625 Bensheim

Details of many more original accessories and other extras can be found at: www.suzuki.eu

Your Suzuki partner:



D55 (1965)

At the forefront of outboard technology since 1965

We created our first outboard motor in 1965 and will be celebrating the 50th anniversary of the D55 in 2015. We have come a long way since then and our current range of four stroke outboards is second to none in the market place. Our engineers are passionate about boating and spend all of their time perfecting our fuel-efficient and technologically advanced four stroke outboard motors so that our products enable you to maximize your time on the water. So, from the lightweight and portable DF2.5 to the award winning power of the DF300AP, we've got an outboard to suit your way of life.

Suzuki is more than marine.



Automobile, motorbike and marine - 100 years of innovation. Visit our homepage via QR-code and learn more about Suzuki - way of life.



Way of Life!